

Intelligent DIN-Rail Switch Monitor Installation Guide

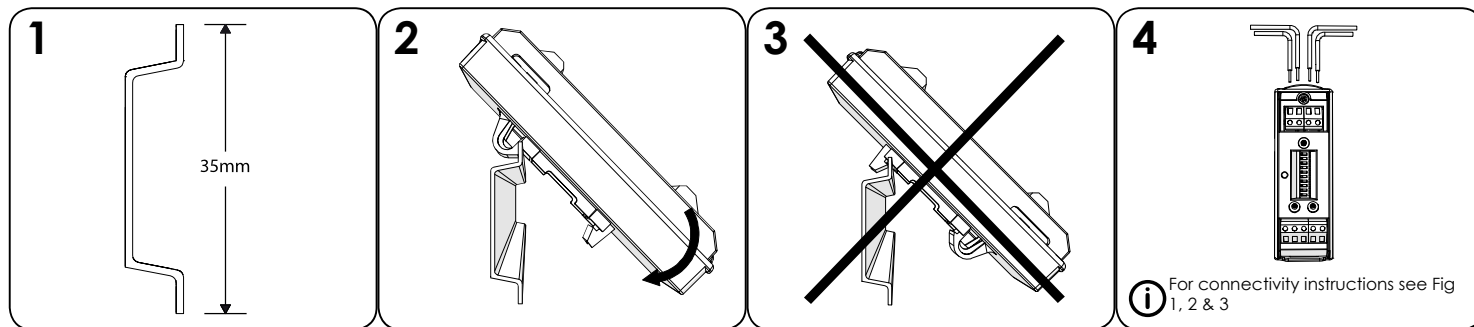

Part No	Product Name
SA4700-300APO	Intelligent DIN-Rail Switch Monitor

Technical Information

All data is supplied subject to change without notice. Specifications are typical at 24V, 25°C and 50% RH unless otherwise stated.

- Supply Voltage** 17-35V dc
- Quiescent Current** 500µA
- Power-up Surge Current** 900µA
- LED Current** 1.6mA per LED
- Maximum Loop Current** 1A
(I_e max; L1 in/out)
- Operating Temperature** -40°C to 70°C
- Humidity** 0% to 95% RH
(no condensation or icing)
- Approvals** EN 54-17 & EN 54-18

For additional technical information please refer to the following documents which are available on request.

PP2563 - Intelligent DIN-Rail Switch Monitor

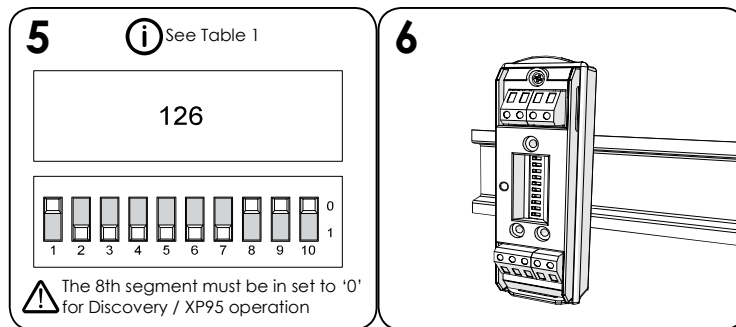

Addressing

Table 1

		XP95 / Discovery Systems	CoreProtocol Systems
Segment	1	Sets the address	Sets the address
	2		
	3		
	4		
	5		
	6		
	7		
	8	Set to '0' (Fault value is returned if set to '1')	
MCP	Priority interrupt - enables MCP behaviour	Enables 30 second delay into alarm	
DLY	Enables 30 second delay into alarm	Enables priority enabled switch monitor behaviour	

Note: On mixed systems addresses 127 and 128 are reserved. Refer to system's panel manufacturer for further information.

Address Setting Examples

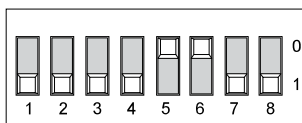
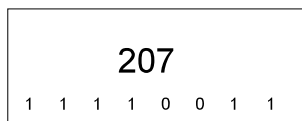
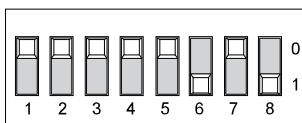
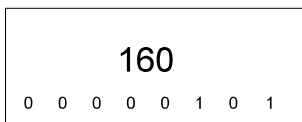
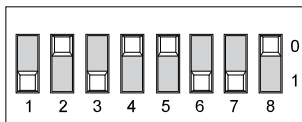
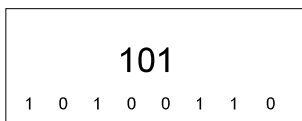
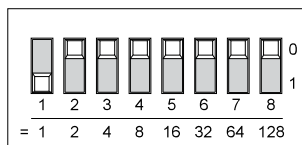

Connectivity Examples

Fig. 1 Standard resistive monitoring mode

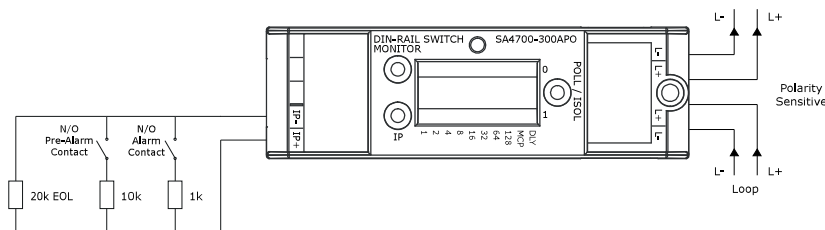

Fig. 2 Normally open monitoring mode (compatible with CoreProtocol only)

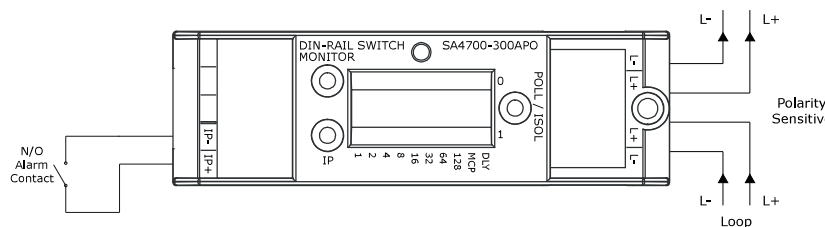
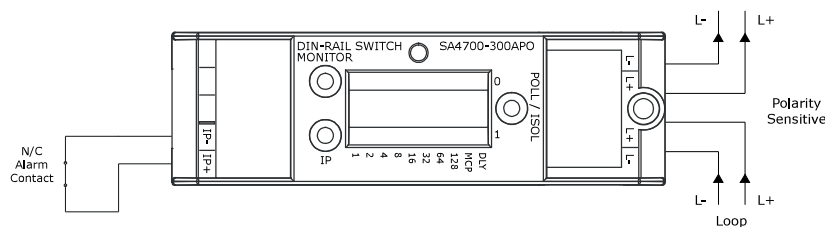

Fig. 3 Normally closed monitoring mode (Compatible with CoreProtocol only)



When operated under XP95 or Discovery Protocols, EN54-13 type 2 devices can be connected. In case EN54-13 type 1 devices need to be connected they must be installed directly next to this module, with no transmission path according to EN 54-13.

LED Status Indicator

POLL/ ISO	Flashing Green	Device Polled
	Continuous Yellow	Isolator Active
IP	Continuous Red	Input Active
	Continuous Yellow	Input Fault

Note:
Not all LEDs can be on simultaneously.

Commissioning

The installation must conform to BS5839-1 (or applicable local codes).

Caution

Unit damage. No electrical supply greater than 50V ac rms or 75V dc should be connected to any terminal of this Switch Monitor.

Troubleshooting

Before investigating individual units for faults, it is important to check that the system wiring is fault free. Earth faults on data loops or interface zone wiring may cause communication errors. Many fault conditions are the result of simple wiring errors. Check all connections to the unit.

Problem	Possible Cause
No response or missing	Incorrect address setting
Fault condition reported	Incorrect loop wiring
Analogue value unstable	Incorrect input wiring
	Incorrect end-of-line resistor fitted
Constant alarm or pre-alarm	Dual address
	Loop data fault, data corruption
Isolator LED on	Incorrect wiring
	Incorrect end-of-line resistor fitted
	Short-circuit on loop wiring
	Wiring reverse polarity
	Too many devices between isolators

Mode Table*

Mode	Description
1	DIL Switch XP Mode
2	Switch monitor - normal resistance bands with alarm delays
3	priority switch monitor - normal resistance bands
4	Switch monitor - N/C input with alarm delays
5	Priority switch monitor - N/C input

*CoreProtocol enabled systems only