

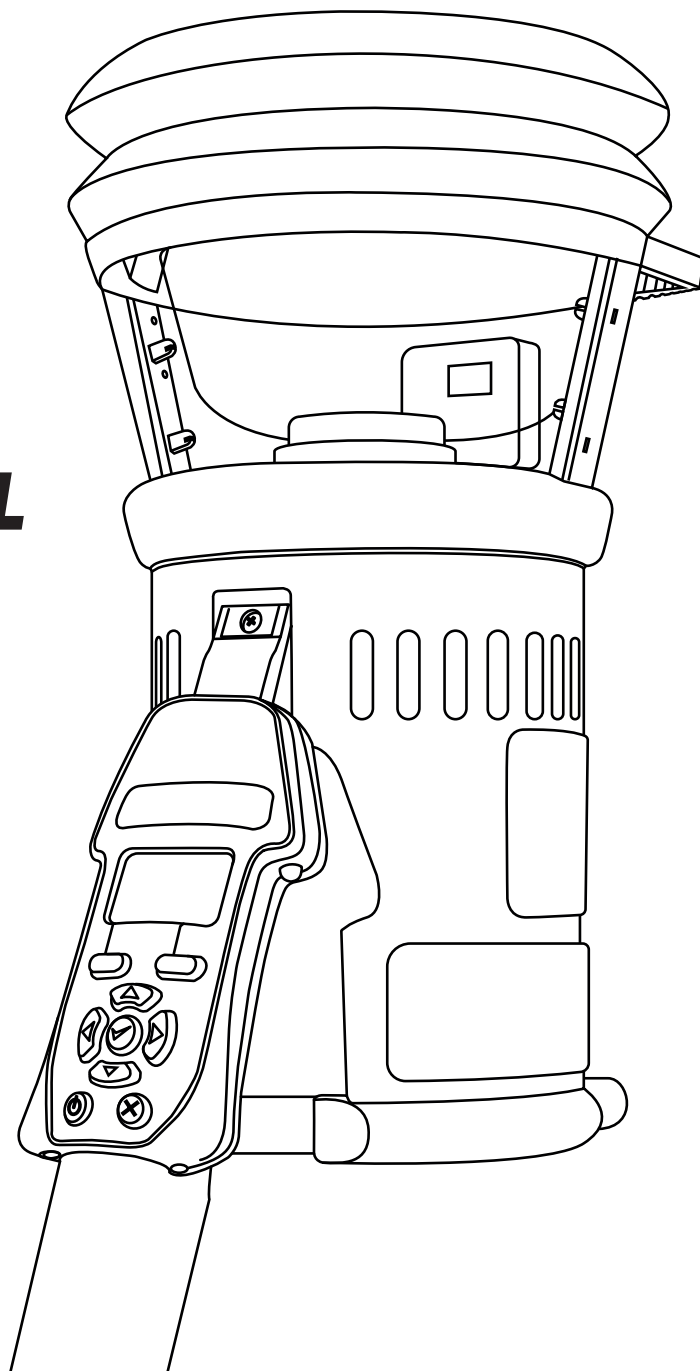

USER MANUAL

2000 SERIES



IMPORTANT INFORMATION

READ THIS USER MANUAL COMPLETELY BEFORE USING YOUR TESTIFIRE.

SAVE THIS USER MANUAL - SAVE ALL SAFETY AND OPERATIONAL INSTRUCTIONS FOR FUTURE REFERENCE. TAKE NOTE OF THE WARNINGS - READ CAREFULLY AND FOLLOW ALL WARNING LABELS ON THE PRODUCT AND THOSE DESCRIBED IN THIS USER MANUAL.

THE FOLLOWING SYMBOLS ARE USED THROUGHOUT THIS USER MANUAL AND ON THE PRODUCT:



This symbol on the product indicates that there is a safety hazard or an operation requiring care to avoid damage to the product or environment. You must read the appropriate sections of the User Manual to understand the nature and severity of all the potential hazards present and the action you must take.



This symbol on the product warns you of hot surfaces or heat by convection.



This symbol on the product indicates that you should read and understand this User Manual before using this product.



This symbol on the product indicates that this part of the device is susceptible to static damage.



To comply with WEEE (Waste Electrical & Electronic Equipment) Regulations the crossed out refuse container symbol on this product or literature indicates that it should not be disposed with other business waste at the end of its working life. To help ensure that valuable resources are reused and recycled, and to prevent possible harm to the environment or human health from uncontrolled waste disposal, please separate this from any other types of waste.

CAUTION

THIS PRODUCT IS INTENDED TO BE USED AT HEIGHT. EXERCISE GREAT CARE AND ALWAYS WEAR APPROPRIATE PPE (PERSONAL PROTECTIVE EQUIPMENT) WHEN OPERATING ABOVE HEAD HEIGHT IN ORDER TO AVOID THE RISK OF INJURY.

- DO NOT OVER REACH. Keep proper footing and balance at all times. Proper footing and balance enables better control of the equipment in unexpected situations.
- Pay particular attention to avoid contact with overhead items such as light fittings, overhead power cables and any other objects that could be accidentally dislodged which might cause danger to the operator or anyone else in the vicinity.

WARNING

THIS PRODUCT CONTAINS HOT PARTS.

- DO NOT TOUCH the heat element. It may be very hot immediately after use and may burn if touched.
- DO NOT TOUCH the tip of the CO capsule when it has been removed if the unit has been in operation within the previous 5 minutes. It will be very hot immediately after use and may burn if touched.
- DO NOT insert fingers into the aperture from where the CO capsule has been removed. There are very hot surfaces which may burn if touched.

WARNING

- This product is designed for indoor use only and should not be subject to, or used in, a wet environment.
- To protect the high-precision technology contained in Testifire, never leave Testifire in the places listed below, whether if in use or in storage:
 - Places where temperatures and/or humidity are high or go through extreme changes. Direct sunlight, or near other heat sources (stoves, radiators, etc.) Always observe the operating and storage environment restrictions detailed in the Technical Specifications
 - In sandy or dusty environments.
 - In places prone to strong vibration.
 - Near to sources of static or radio waves.
 - Wet or moist environments. Testifire is designed for indoor use only
- Stop using Testifire immediately if you notice any unusual odours; liquids or noise coming from it. Switch off immediately and consult technical support.
- Testifire is not designed for use in hazardous areas (those containing explosive vapour or dust).
- The Battery Baton should be removed when Testifire is not in use. This will prevent the gradual discharge of the battery and prevent possible accidental operation of the head unit.
- Do not use your Testifire if it is not operating properly. Consult the Troubleshooting section of this manual and if required seek technical advice.
- If the equipment is used in a manner not specified by the manufacturer, the protection provided by the equipment may be impaired.
- Use only approved accessories that are recommended by the manufacturer for your Testifire model.
- Always disconnect the battery from the charger once fully charged. Leaving it connected, particularly when using a vehicle power supply can lead to overheating and damage to the battery.
- Take care when handling and storing your Testifire. Dropping on to a hard surface could damage it.
- If your Testifire unit becomes damaged do not use it. Switch off immediately and consult technical support.

WARNING

This product emits small amounts of carbon monoxide (CO) gas which is a harmful, odourless gas. DO NOT INHALE directly from the duct during a CO test or within 5 minutes of conducting a CO test.

NOTE: UNDER NORMAL OPERATING CONDITIONS, THIS EMISSION WILL PRESENT NO HARM TO THE USER. FOR ADDITIONAL INFORMATION PLEASE REFER TO THE SEPARATE SAFETY INFORMATION PROVIDED.

CONTENTS

1 GENERAL INSTRUCTIONS	4	7 SIMULTANEOUS TESTING	24
1.1 WARRANTY		7.1 SMOKE/HEAT	
1.2 ACKNOWLEDGEMENT		8 TESTIFIRE INFRARED REMOTE CONTROL	25
1.3 RECYCLING		9 SETTINGS	26
1.4 CE DECLARATION		10 REMOVING & REPLACING CONSUMABLES	28
1.5 CARE OF YOUR TESTIFIRE		10.1 REMOVING THE SMOKE CAPSULE	
1.6 GENERAL CARE		10.2 REPLACING THE SMOKE CAPSULE	
2 TESTIFIRE 2000 SERIES INTRODUCTION	5	10.3 REMOVING THE CO CAPSULE	29
KIT CONTENTS	6	10.4 REPLACING THE CO CAPSULE	
3 PREPARATION FOR USE	8	10.5 REMOVING THE BATTERY	30
3.1 CHARGING THE BATTERY		10.6 REPLACING THE BATTERY	
3.2 INSERTING THE BATTERY		11 REMOVING & REPLACING SPARES	31
3.3 INSERTING THE SMOKE CAPSULE	9	11.1 REMOVING THE CLEAR CUP	
3.4 INSERTING THE CO CAPSULE		11.2 REPLACING THE CLEAR CUP	
4 GETTING STARTED	10	11.3 REMOVING THE MEMBRANE	
4.1 POWERING ON TESTIFIRE		11.4 REPLACING THE MEMBRANE	
4.2 INTERFACE & MAIN MENU	11	12 CONSUMABLES & ACCESSORIES	32
4.3 ADJUSTING HEAD UNIT ANGLE	12	13 TECHNICAL SPECIFICATIONS	33
4.4 TESTING HIGH PROFILE DETECTORS		14 TROUBLESHOOTING & SUPPORT	34
5 SINGLE TEST	13	14.1 IDENTIFYING ERRORS	
5.1 DEFAULT SMOKE TEST		14.2 GENERAL CARE	
5.2 HEAT TESTING	14	14.3 BATTERIES & CHARGERS	
5.3 CO TESTING	15		
5.4 CLEARING A DETECTOR			
6 SEQUENTIAL TESTING	16		
6.1 SMOKE TEST + CLEARING			
6.2 SMOKE TEST + HEAT TEST	18		
6.3 SMOKE TEST + CLEAR + HEAT TEST	20		
6.4 SMOKE + CLEAR + HEAT + CO TEST	22		

1 GENERAL INSTRUCTIONS

1.1 WARRANTY

In addition to any other express warranty given in writing by the Company in relation to the Goods, the Company warrants that the Goods supplied under these terms and conditions will be in accordance with the specification (if any) contained in the Purchase Order, and will be free from defects in workmanship and material for a period of 18 months from the date of delivery to the Buyer or for a period of 12 months after the date of sale by the Buyer to the final customer whichever period is the shorter.

1.2 ACKNOWLEDGEMENT

Testifire®, Solo™ and Battery Baton™ are registered marks of No Climb Products Ltd. All other brand names mentioned are trademarks or registered marks of their respective holders, and are hereby acknowledged.

©2017 No Climb Products Ltd. All Rights Reserved.

1.3 RECYCLING

The packaging can be easily separated into the following materials:

- Cardboard (outer box)
- Cardboard (inner buffers, boxes)
- Polyethylene (capsule bags)
- Plastic (capsule caps)

Please dispose in line with local environmental requirements.

WEEE (WASTE ELECTRICAL & ELECTRONIC EQUIPMENT) REGULATIONS

Testifire and Testifire capsules are suitably marked to be recycled in accordance with your local environmental requirements.

Alternatively these items may be returned to the manufacturer via your reseller for disposal in compliance with WEEE (Waste Electrical & Electronic Equipment) Regulations.

1.4 CE DECLARATION

This product and its associated components are designed and manufactured to be fully compliant with the requirements of the following EU Directives for CE marking:

- EMC Directive 2014/30/EU of the European Parliament and of the Council of 26 February 2014 on the harmonisation of the laws of the Member States relating to electromagnetic compatibility (recast).
- Low Voltage Directive 2014/35/EU of the European Parliament and of the Council of 12 December 2006 on the harmonisation of the laws of Member States relating to electrical equipment designed for use within certain voltage limits.
- RoHS Directive 2011/65/EU of the European Parliament and of the Council of 8 June 2011 on the restriction of the use of certain hazardous substances in electrical and electronic equipment.
- BAWBA Directive 2006/66/EC of the European Parliament and of the Council of 6 September 2006 on batteries and accumulators and waste batteries and accumulators and repealing Directive 91/157/EEC.

1.5 CARE OF YOUR TESTIFIRE

- Only use genuine, specified batteries with your testifire.
- Do not get dirt, sand, liquids, or other foreign matter on the terminals.
- Do not touch the terminals with metal objects.
- Do not cover the battery or charger when in use.
- Do not place charging battery in or near a heat source
- Always disconnect the battery from the charger as soon as it is fully charged, especially if the power could be repeatedly disrupted e.g. when using in-vehicle power. Leaving the battery connected may lead to overheating and damage to the battery.
- Solo 727 chargers will only work with Solo 770 battery batons. They will not charge Solo 760 batteries.

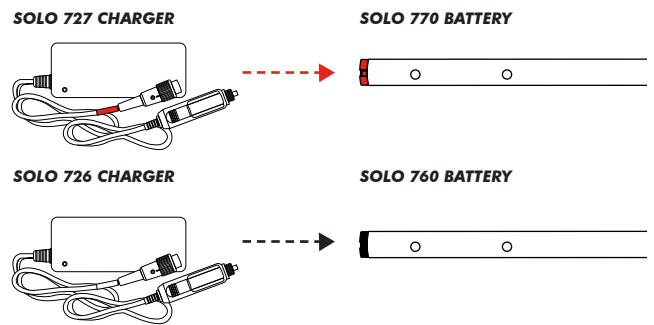

NOTE: DIRT THAT GETS INTO THE CUP COULD GET INTO THE UNIT THROUGH THE SMOKE/HEAT/CO DUCT OPENING AND CAUSE THE UNIT TO FAIL. ALWAYS KEEP THE CUP CLEAN TO ENSURE RELIABLE OPERATION.

1.6 GENERAL CARE

DO NOT DROP OR EXPOSE TESTIFIRE TO WATER.

Always store Testifire, batteries and chargers in a suitable bag when not in use.

2 TESTIFIRE 2000 SERIES INTRODUCTION

Thank you for purchasing the Testifire Multi-Sensor Detector Tester

This manual is designed to assist you to get the best and most efficient use of the Testifire 2000 series and provides all the information required to perform routine service and maintenance tasks with ease.

Testifire includes advanced technology that simplifies functional testing of smoke & heat detectors.

1. Bellows
2. Infrared Beam
3. Inner Clear Cup
4. Clear Cup
5. Main Duct for Heat
6. Smoke Capsule Cover
7. Test LED
8. Status LED
9. User Interface Display
10. CO Capsule Cover
11. Infrared Remote Control Receivers
12. Adjustable Handle

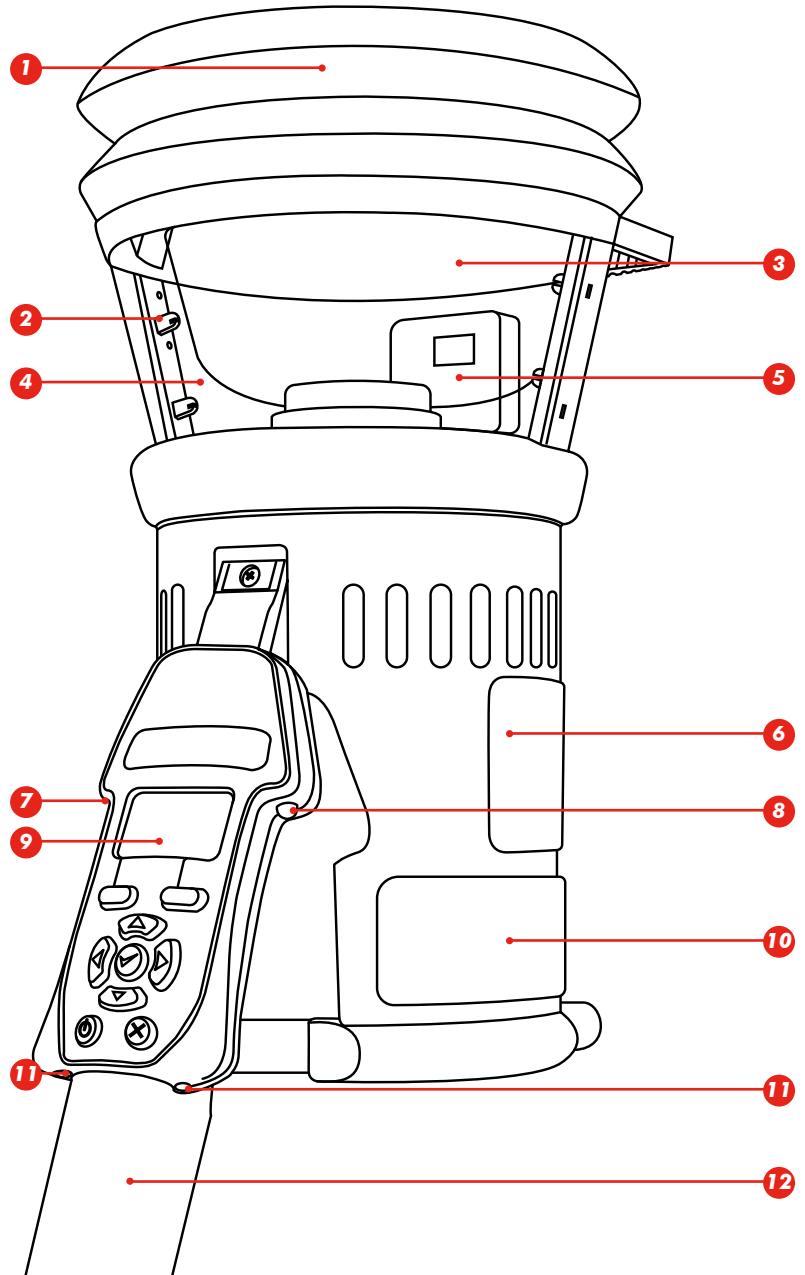

USER INTERFACE KEYPAD

1. Menu
2. Status
3. Navigation
4. Enter/Confirm
5. On/Off
6. Return/Escape

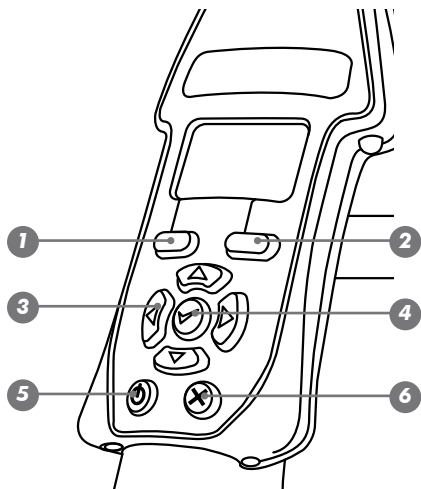

KIT CONTENTS

TESTIFIRE 2001-1 SMOKE, HEAT
& CO KIT CONTAINING:

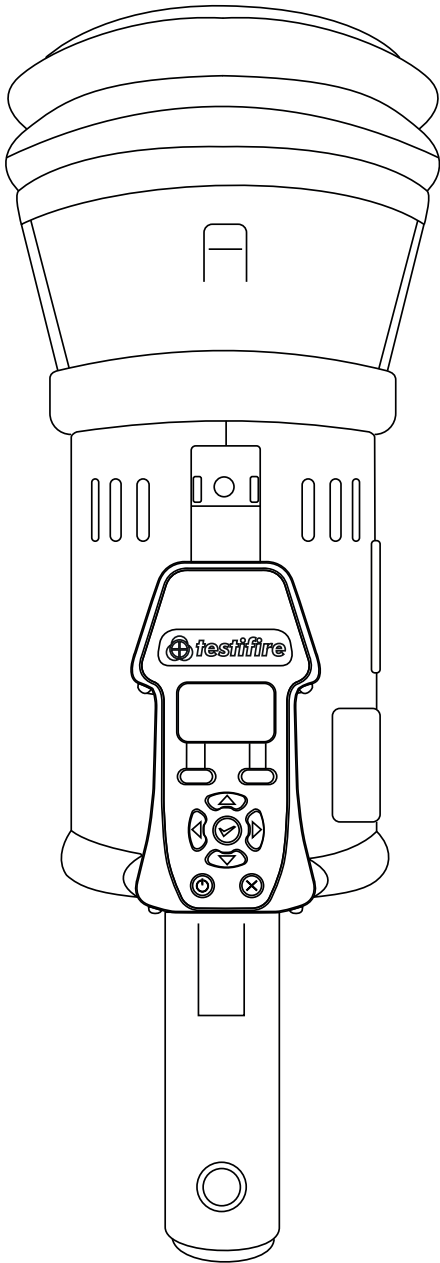

1x TESTIFIRE 2000 HEAD UNIT

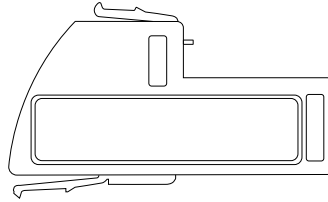

1x TS3 SMOKE CAPSULE

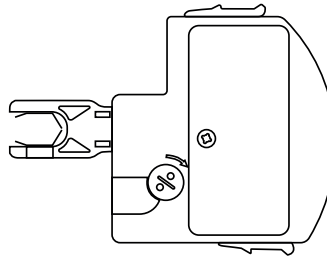

1x TC3 CO CAPSULE

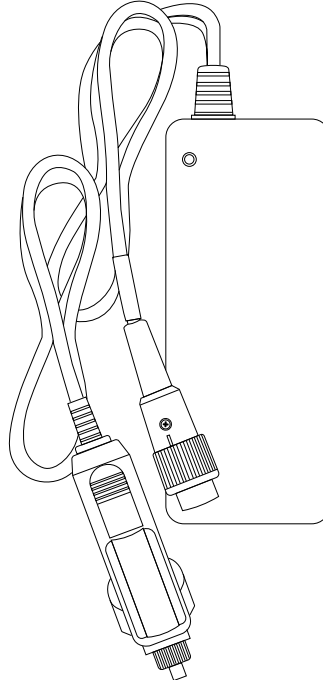

1x SOLO 727 CHARGER

1x SOLO 770 BATTERY



**TESTIFIRE 2001 SMOKE, HEAT
& CO KIT CONTAINING:**

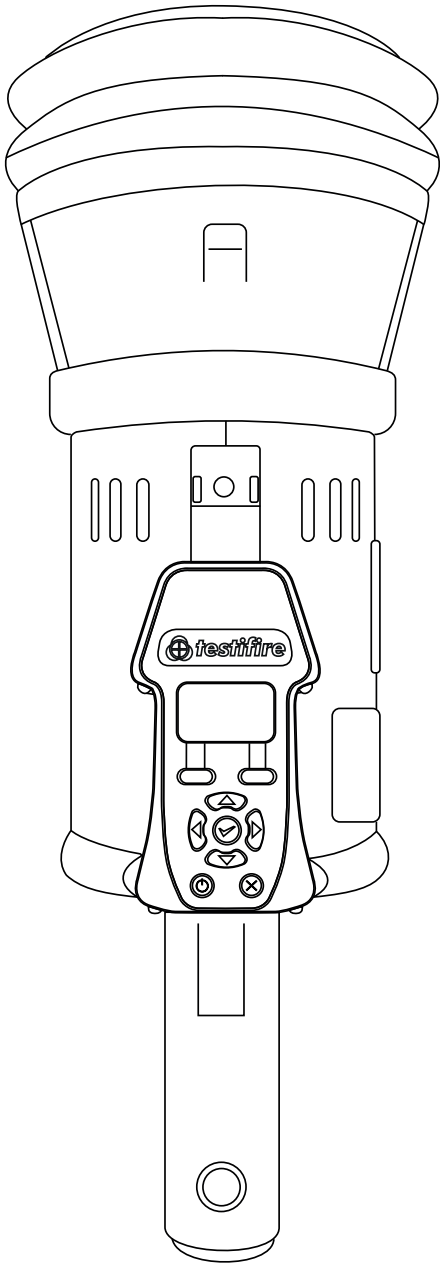

1x TESTIFIRE 2000 HEAD UNIT

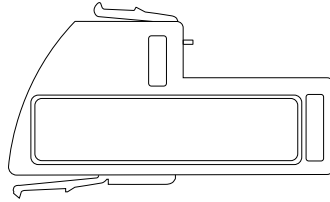

1x TS3 SMOKE CAPSULE

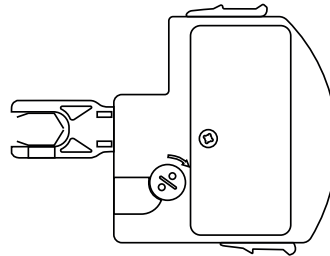

1x TC3 CO CAPSULE

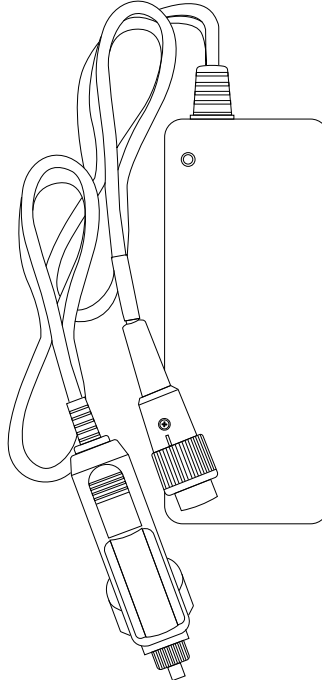

1x SOLO 727 CHARGER

2x SOLO 770 BATTERY

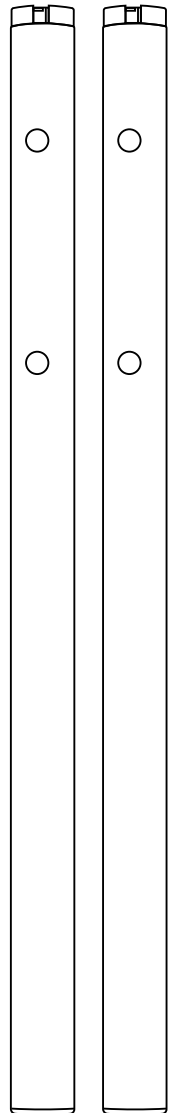

3 PREPARATION FOR USE

3.1 CHARGING THE BATTERY

Solo NiMH Battery Batons are used to power Testifire and enable it to be fitted to Solo Access Poles.

WARNING
DO NOT ATTEMPT TO USE OR CHARGE THE BATTERY IF EITHER THE UNIT OR THE BATTERY CONNECTION POINT ARE DAMAGED. NEVER CONNECT AC AND DC POWER AT THE SAME TIME.

The Solo 770 Battery Baton must be charged using a Solo charger before using Testifire. To ensure maximum duration of testing, it should be fully charged for each use. A Solo 727 charger will fully charge a Solo 770 battery in 60-90 minutes

FIGURE 1

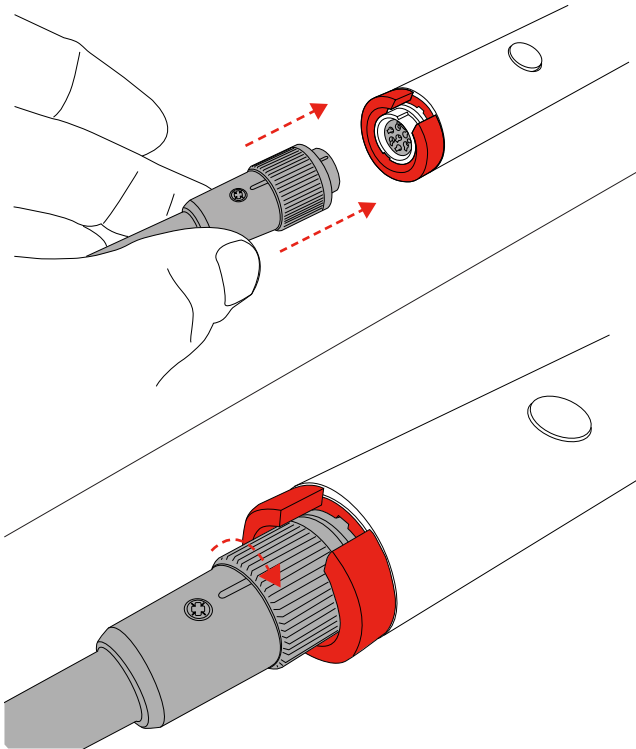

1. Connect charger to power outlet / vehicle accessory socket using power cable supplied / umbilical DC connecting lead respectively. LED will not illuminate permanently.
2. Connect the Battery Baton to the charger via the seven pin polarised connector and turn the locking ring. (Fig. 1)
3. LED will flash red/green for approx 5 minutes, then illuminate red only to indicate fast charging. LED illuminates green only when battery is fully charged.
4. Charging times will depend on the discharge state of the Battery Baton. Charge times can be 75-90 minutes when charging a fully discharged Battery Baton.
5. Disconnect battery from the charger once fully charged to prevent overheating and damage to the battery.

3.2 INSERTING THE BATTERY

CAUTION
ENSURE CORRECT ORIENTATION WHEN INSERTING THE BATTERY BATON INTO TESTIFIRE. DO NOT USE UNDUE FORCE TO INSERT. REMOVE BATTERY FROM TESTIFIRE WHEN NOT IN USE.

1. Hold the Testifire head unit by the handle and press the upper spring button on the Battery Baton. Align the button with the location hole in the handle and push the Battery Baton into the handle until the button springs up through the hole. (Fig. 2)
2. Insert the other end of the Battery Baton into the Solo access pole and press the lower spring button. Align it with the location hole and push the Battery Baton further into the pole until the button springs up through the hole.

FIGURE 2

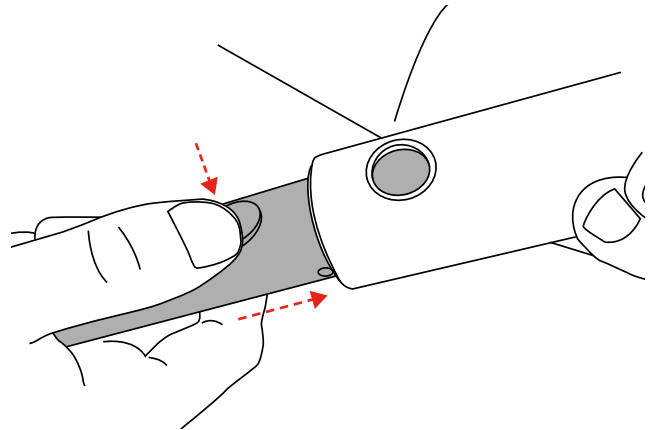

WARNING
ALWAYS DISCONNECT THE BATTERY FROM THE CHARGER AS SOON AS IT IS FULLY CHARGED, ESPECIALLY IF THE POWER COULD BE REPEATEDLY DISRUPTED E.G. WHEN USING IN-VEHICLE POWER. LEAVING THE BATTERY CONNECTED MAY LEAD TO OVERHEATING AND DAMAGE TO THE BATTERY.

3.3 INSERTING THE SMOKE CAPSULE

1

Remove the spring clip protector cap from the capsule.

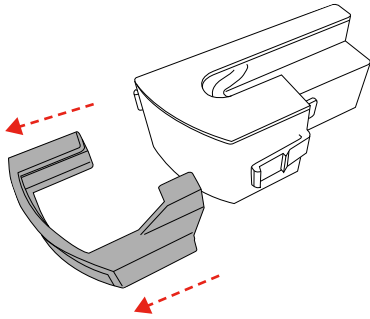

2

Holding the capsule by the spring clips with the label on the underside, insert the capsule. Ensure that the clips spring out positively on both sides of the capsule to engage correctly with the port.

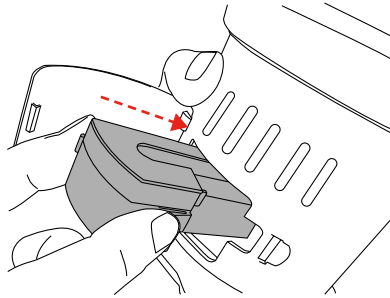

3

Close the access cover securely.

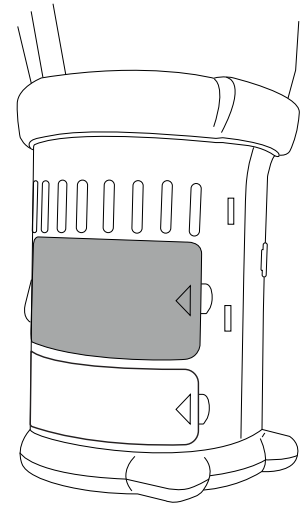

3.4 INSERTING THE CO CAPSULE

1

Remove the tip protector cap from the capsule.

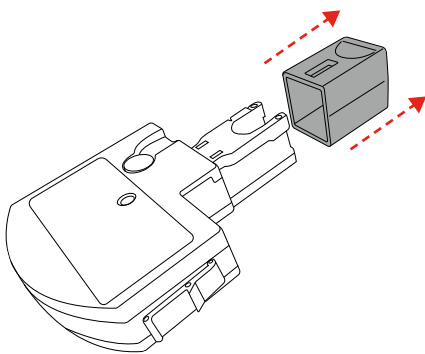

2

Holding the capsule by the spring clips with the label facing upwards, insert the capsule. Ensure that the clips spring out positively on both sides of the capsule to engage correctly with the port.

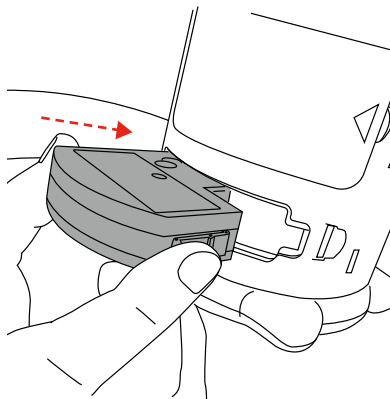

3

Close the access cover securely.

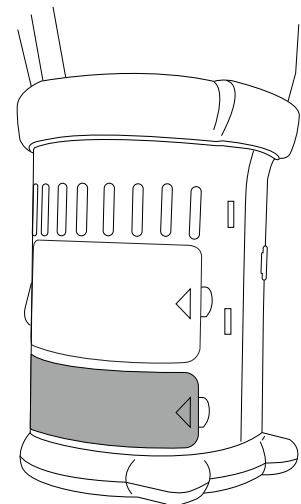

NOTE

Smoke & CO Capsules are non-refillable. Only replace with genuine Testifire TS3 Smoke Capsules & TC3 CO Capsules. It is recommended the capsule should be removed from the unit when not in use for a few days.



CAUTION

- DO NOT TOUCH THE CONTACTS ON THE PCB ON THE CAPSULE. STATIC ELECTRICITY MAY DAMAGE THEM AND CONTAMINATION OF THE CONTACTS MUST BE AVOIDED.
- ALLOW THE CO CAPSULE TO COOL DOWN BEFORE REMOVING

4 GETTING STARTED

4.1 POWERING ON TESTIFIRE

1

Press and hold the red power button for 2 seconds.



2

The first time the unit is powered-on you will be prompted to select the Testifire operating language for your region. Use the up and down arrow keys to navigate and enter key to select your required operating language

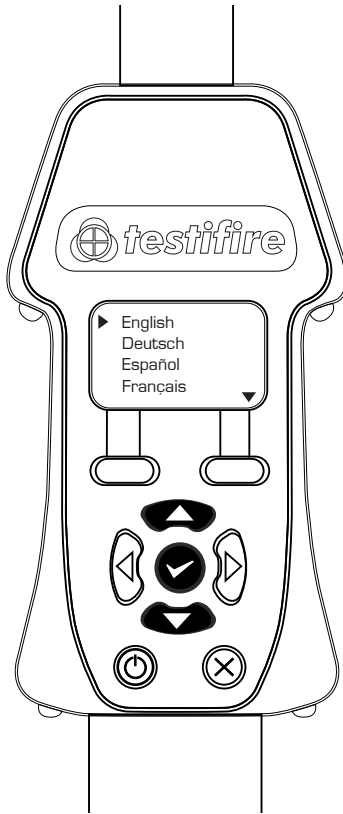

3

This will display a confirmation screen. Press the menu key to select or the status' key to cancel. Once the language has been selected the main menu will be displayed.



NOTE

If not used within 16 days or when a Smoke Capsule has been replaced, Testifire will self-prime at power-on, prior to displaying the main menu. This is Indicated by a message 'Preparing for use'

NOTE





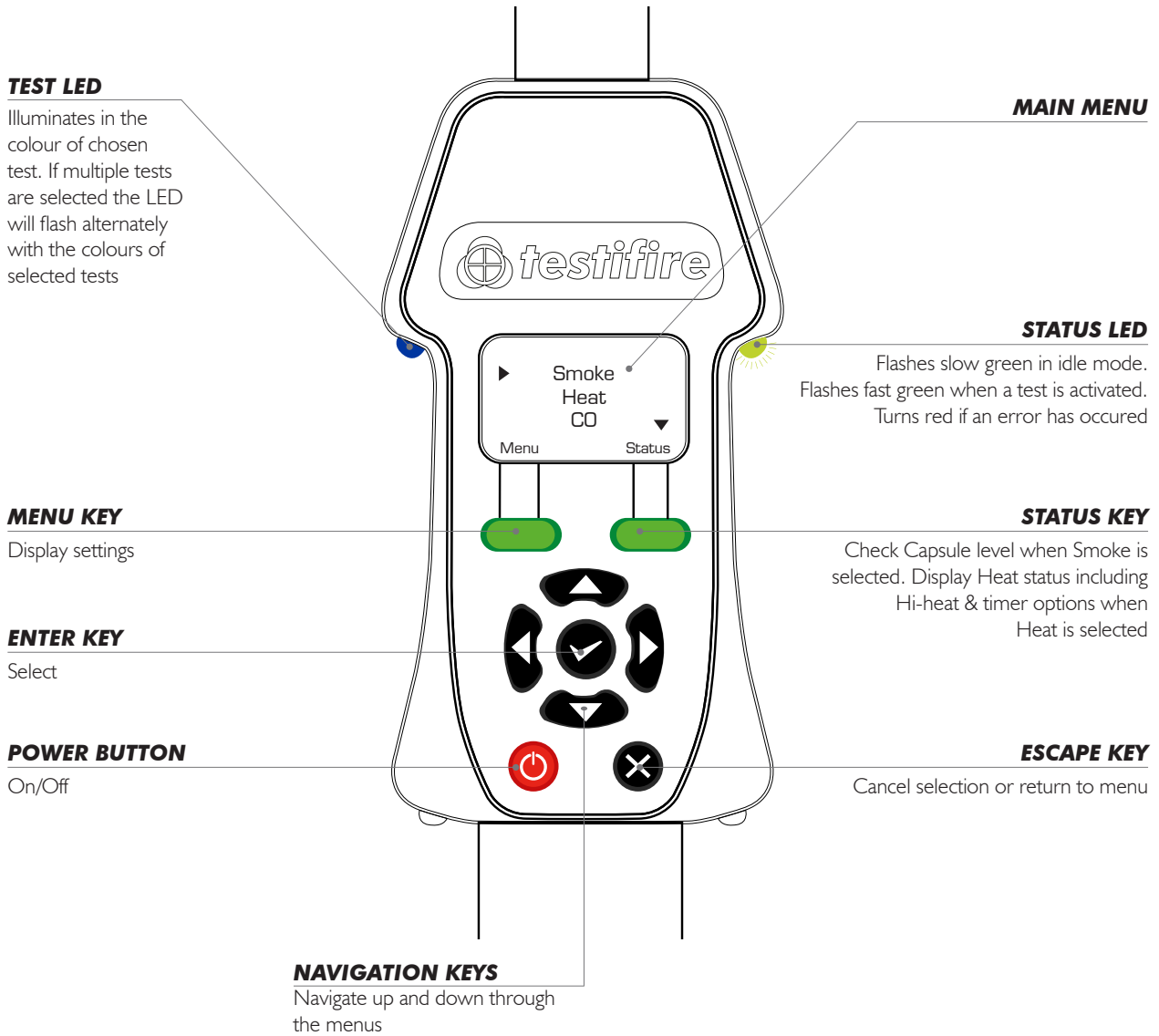

If the unit is left in Standby mode for more than 5 minutes, it will power off to conserve the battery.

4.2 INTERFACE & MAIN MENU









LED REFERENCE CHART

TEST LED

-  **Blue** = Smoke
-  **Red** = Heat
-  **Green** = CO
-  **Clear** = Clearing
-  **Flashing Blue/Red/Green** = Smoke/Heat/CO simultaneous test
-  **Solid Blue/Red & Green Alternating** = Smoke in progress, Heat/CO sequential test

STATUS LED

-  **Flashing Slow Green** = Idle Mode
-  **Flashing Fast Green** = Operational Mode
-  **Flashing Red** = Battery requires charging
-  **Solid Red** = Error
-  **Flashing Green/Red** = Testifire TimeOut
-  **Double Flashing Green** = CO Element Cooling

4.3 ADJUSTING HEAD UNIT ANGLE

Correct head angle adjustment is important to make sure that the detector to be tested is correctly positioned in the inner clear cup and the user is in a safe and appropriate position to carry out the test.

The detector should touch the base of the Testifire inner clear cup and should be level with the base of the detector.

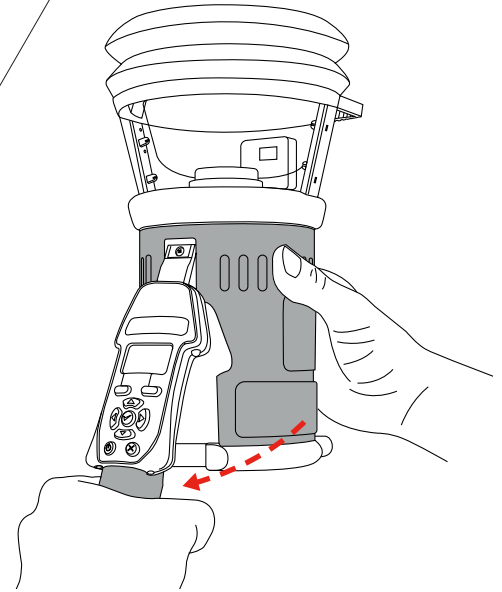
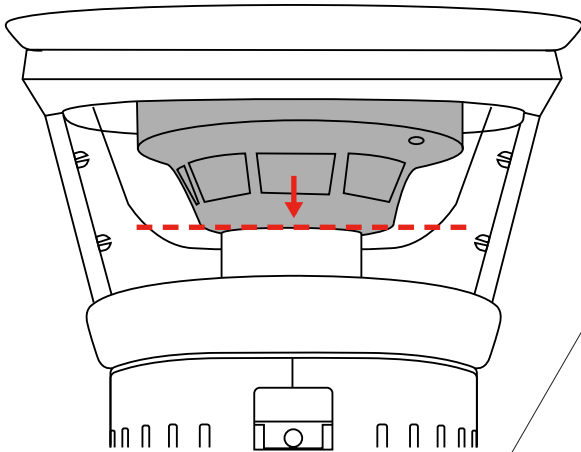

Adjust the head unit for the correct angle to access the detector.. Hold the body of Testifire and gently pull the handle away from the head unit.

The head unit will be free to rotate to the desired position and, on release, it will lock and remain locked for use.

4.4 TESTING HIGH PROFILE DETECTORS

When testing high profile detectors, it may be necessary to remove the inner clear cup to enable the detector to sit in the correct position for a successful test.

The inner clear cup has a semi-circular cut-out on the side nearest to the user interface. Place your finger in the cut-out and carefully lift out the cup. This will allow for correct positioning of the high profile detector within the cup.

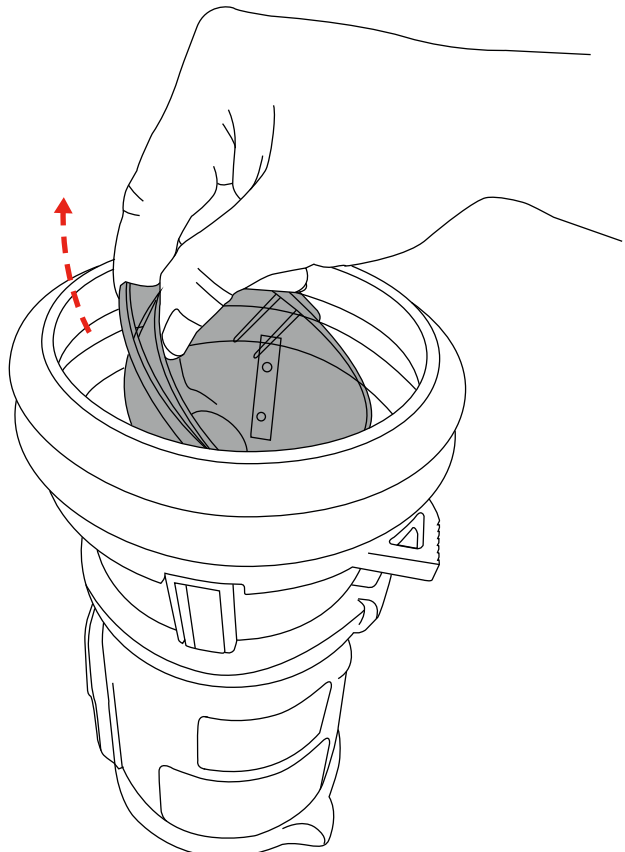

5 SINGLE TEST

5.1 DEFAULT SMOKE TEST

1

After you have completed the preparation procedures, Testifire will be ready for use.

Select smoke test from the main menu by moving the cursor to Smoke.



NOTE

With smoke selected, pressing the status key will display the smoke capsule level.

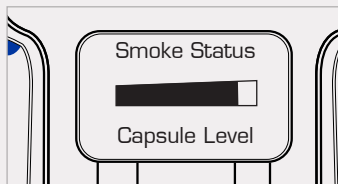

A test cannot be carried out if the capsule is empty

CAPSULE LEVEL SYMBOLS:

- × Capsule Problem
- | Capsule Level Low
- ▱ Capsule Empty

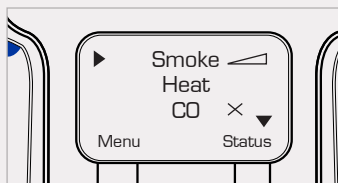

2

An infrared beam across the clear cup controls the test. The test will begin automatically when the head unit is placed over the detector, breaking the infrared beam.

The test LED will flash Blue to indicate that smoke is being generated. The status LED will flash fast Green to show test in progress

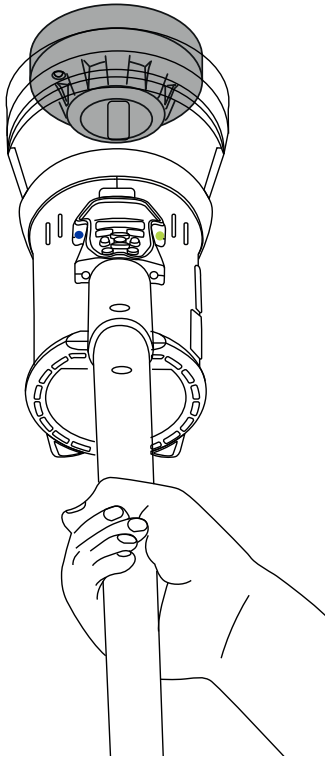

NOTE

During a smoke test a slight 'popping' sound may be heard. This is normal and part of the test procedure.

NOTE

The amount of smoke produced may vary throughout the test

3

When the detector is activated, remove Testifire by lowering it gently. Testifire will return to idle.

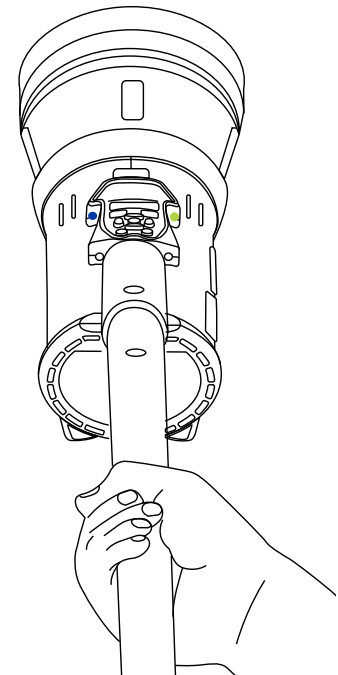
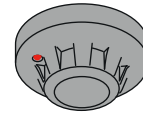

NOTE

If after 2 minutes the test has not completed, Testifire will time-out, highlighted by the status LED flashing Red/Green



CAUTION

AVOID PLACING HANDS NEAR THE DUCT OUTLET DURING HEAT TESTING OR WITHIN 5 MINUTES OF CONDUCTING HEAT TESTING. HOT AIR IS EMITTED FROM THE DUCT AND THE TOP OF THE DUCT WILL GET HOT TO THE TOUCH.

5.2 HEAT TESTING

1

Select Heat test from the main menu by moving the cursor to Heat. The Test LED will turn Red, indicating Testifire is ready to perform a Heat test.



NOTE

Pressing the Status key will display Heat status. Here you can prepare Testifire for Hi-Heat (up to 100°C) by pressing the enter key and then pressing the status key.

The Timer option if selected stops the heat test at 60 seconds, complying with NFPA 72.

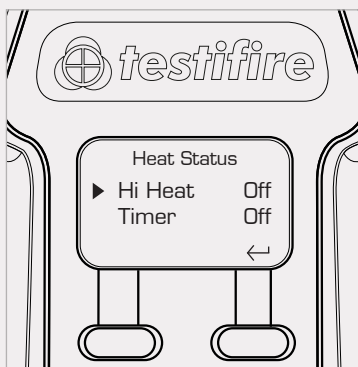

2

The test will begin automatically when the head unit is placed over the detector, breaking the infrared beam.

The test LED will flash Red to indicate that heat is being generated.

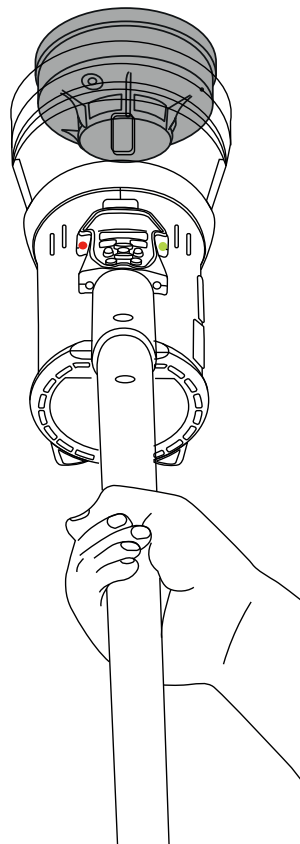

NOTE

Heat is produced in a narrow stream and is not intended to heat the whole inner clear cup. Heat should be directed to the thermal sensor of the detector.

TIP

Rotating Testifire around the detector can speed up a test on detectors with offset thermistors.

3

When the detector is activated, remove Testifire by lowering it gently. Testifire will return to idle.

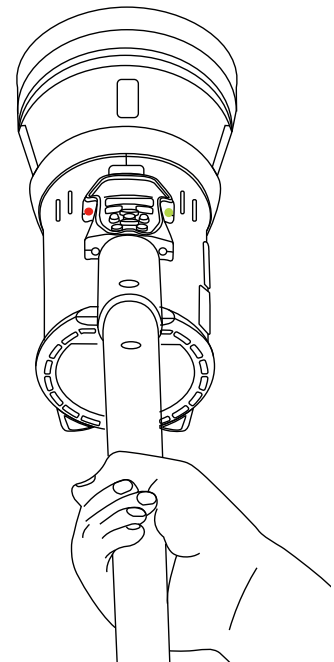
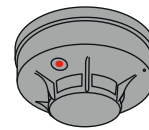

NOTE

If after 2 minutes the test has not completed, Testifire will time-out, highlighted by the status LED flashing Red/Green

WARNING

THIS PRODUCT EMITS SMALL AMOUNTS OF CARBON MONOXIDE (CO) GAS WHICH IS A HARMFUL, ODOURLESS GAS. DO NOT INHALE DIRECTLY FROM THE DUCT DURING A CO TEST OR WITHIN 5 MINUTES OF CONDUCTING A CO TEST.

5.3 CO TESTING

1

Select CO test from the main menu by moving the cursor to CO. The Test LED will turn Green, indicating Testifire is ready to perform a CO test.



NOTE

With CO selected, pressing the status key will display the CO capsule level.

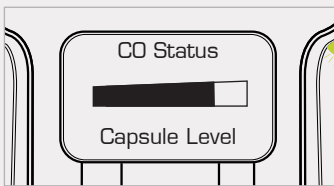

2

The test will begin automatically when the head unit is placed over the detector, breaking the infrared beam.

The test LED will flash Green to indicate that CO is being generated.

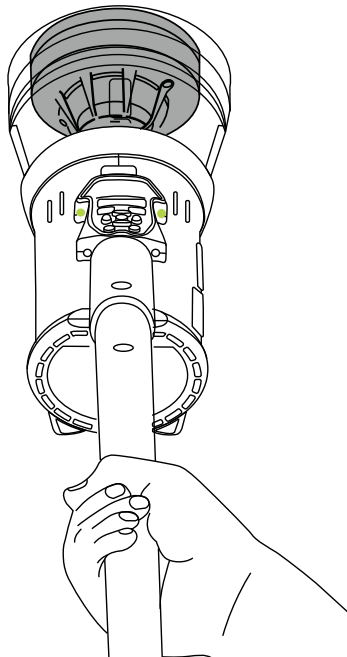

3

When the detector is activated, remove Testifire by lowering it gently. Testifire will cool the CO heater element. The status LED will flash Green and Red with longer gaps between the flashes. Once the CO heater element temperature has been reduced Testifire will return to idle, ready for the next test.

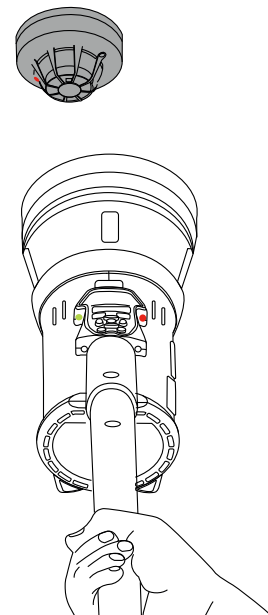

5.3 CLEARING A DETECTOR

1

Select Clear from the main menu. This operation will clear the smoke after a smoke test. It will not clean the internal components of the detector

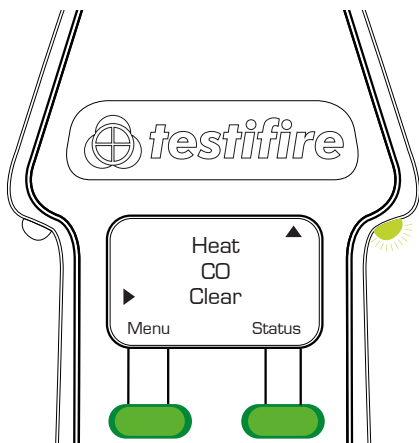

2

Clearing will begin automatically when the head unit is placed over the detector, breaking the infrared beam.

The test LED will not illuminate during clearing.

NOTE

Clearing has a maximum time of 2 minutes. After 2 minutes Testifire will timeout, highlighted by the status LED flashing Red/Green

TIP

Set Clear as part of a sequential test with Smoke e.g. Smoke is **1** and Clear is set to **2**. This will speed up the testing of smoke detectors as the clearing process will remove the possibility of the detector reactivating. See Section on sequential testing for details of how to set up a sequential test.

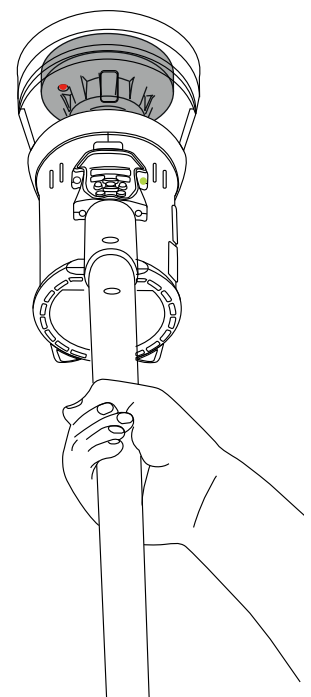

6 SEQUENTIAL TESTING

Using Testifire to carry out a Sequential Test means that a number of operations (Smoke, Heat, CO and Clearing) can be pre-programmed into the unit before it is raised up to the detector. This saves time, reduces handling and enables the testing of certain multi-sensor detectors.

6.1 SMOKE TEST + CLEARING

1

Select smoke test from the main menu by moving the cursor to smoke. Press the enter key to select smoke.

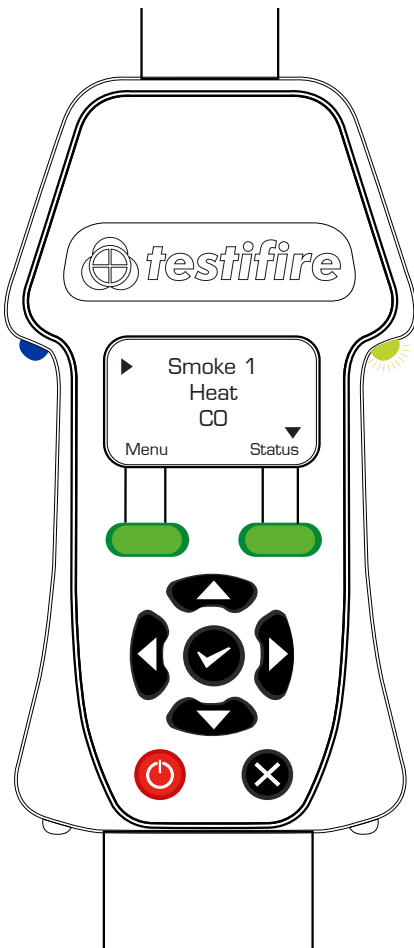

NOTE
To delete a test sequence, simply press the escape key to cancel your selection.

2

Move the cursor down to clear and press the enter key to select clear.

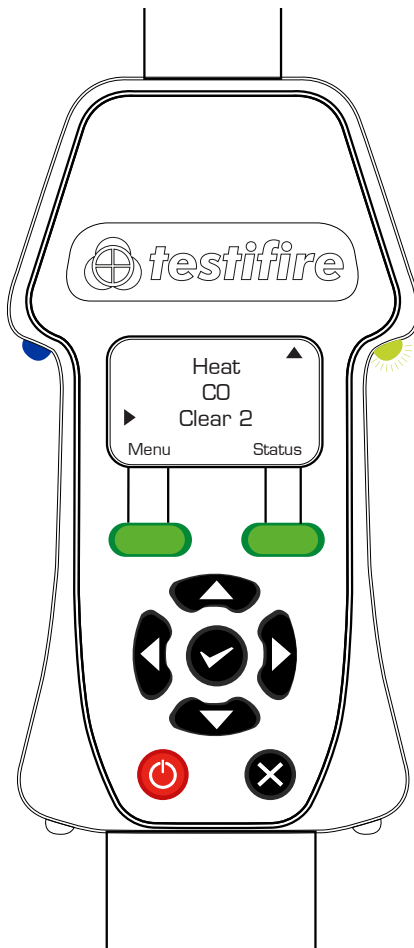

NOTE
The first stimulus selected will be indicated by the number **1** beside it. The next stimulus in the sequential test will be indicated by the number **2** beside it.

3

The initial smoke test will begin automatically when the head unit is placed over the detector, breaking the infrared beam.

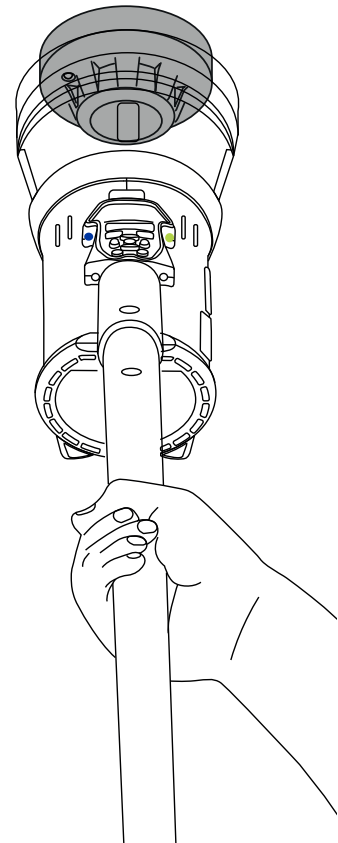

TIP

Any of the test modes can be programmed sequentially in any particular order before raising to a detector. e.g. [Heat **1**, CO **2**, Smoke **3**, Clear **4**]. Or [Smoke **1**, Clear **2**, Heat **3**, CO **4**].

4

When the detector is activated, remove Testifire by lowering it gently. After 2 seconds raise again to begin clearing

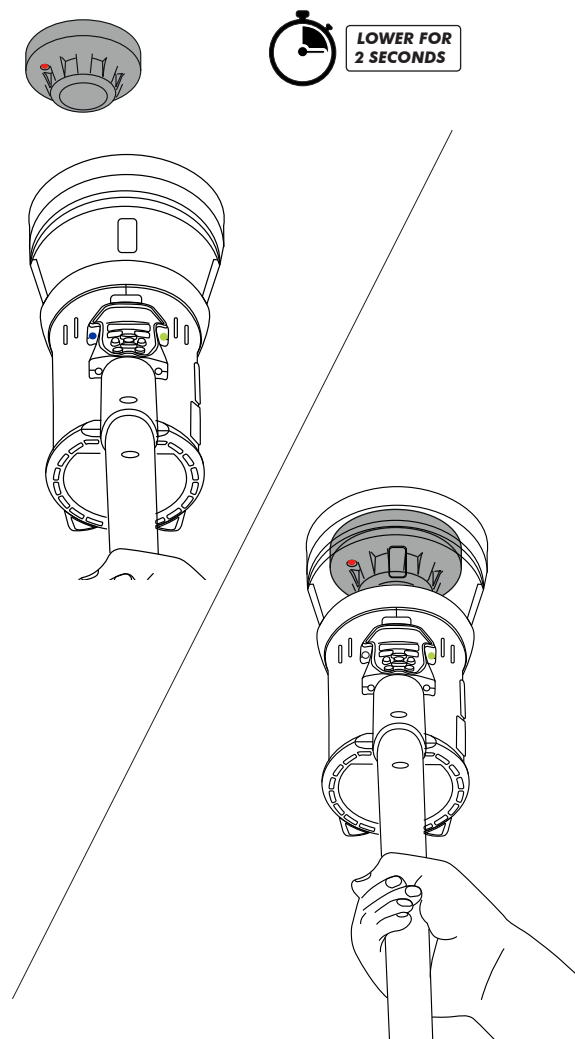

NOTE

If the detector does not re-enter the cup within 10 seconds, the test sequence will reset and return to the first test of the programmed sequence.

5

Lower Testifire once the detector has been cleared. Testifire will return to idle.

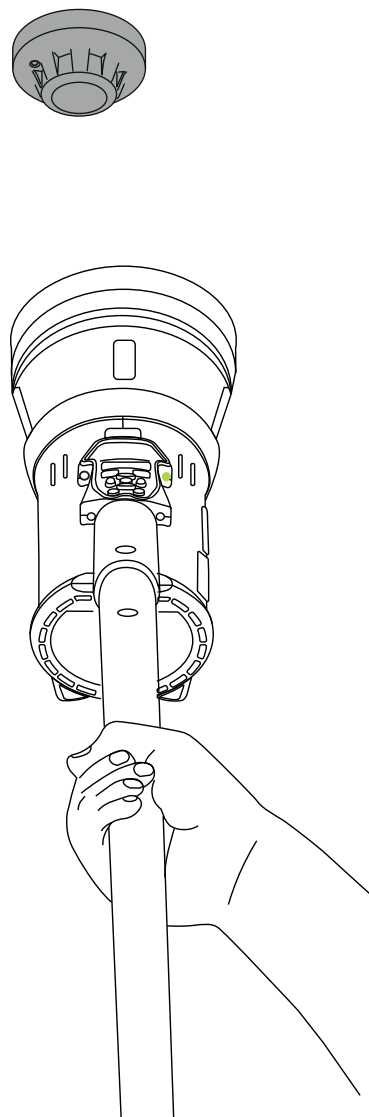

6.2 SMOKE TEST + HEAT TEST

1

Select smoke test from the main menu by moving the cursor to smoke. Press the enter key to select smoke.

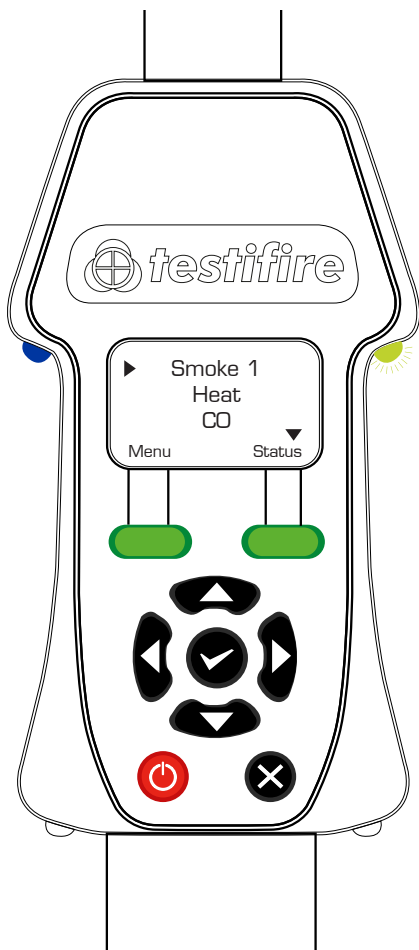

2

Move the cursor down to heat and press the enter key to select.

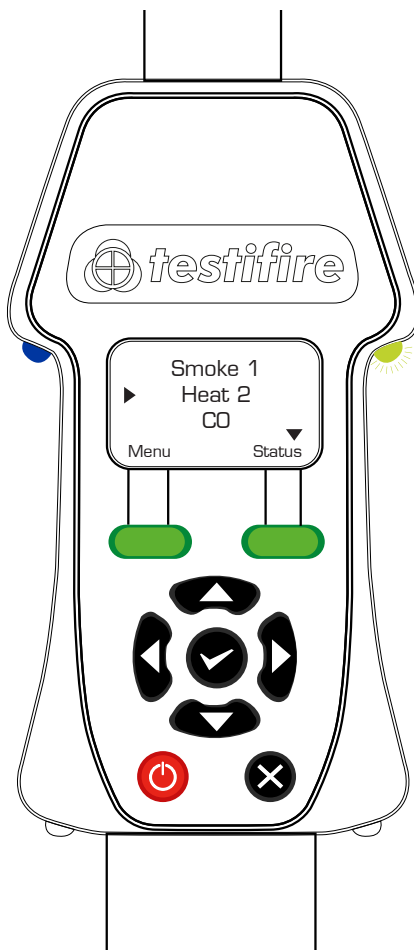

3

The initial smoke test will begin automatically when the head unit is placed over the detector, breaking the infrared beam.

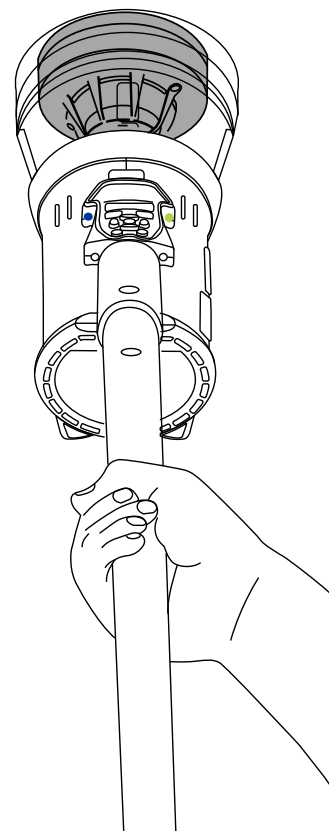

4

When the detector is activated, remove Testifire by lowering it gently. After 2 seconds raise again to begin the heat test

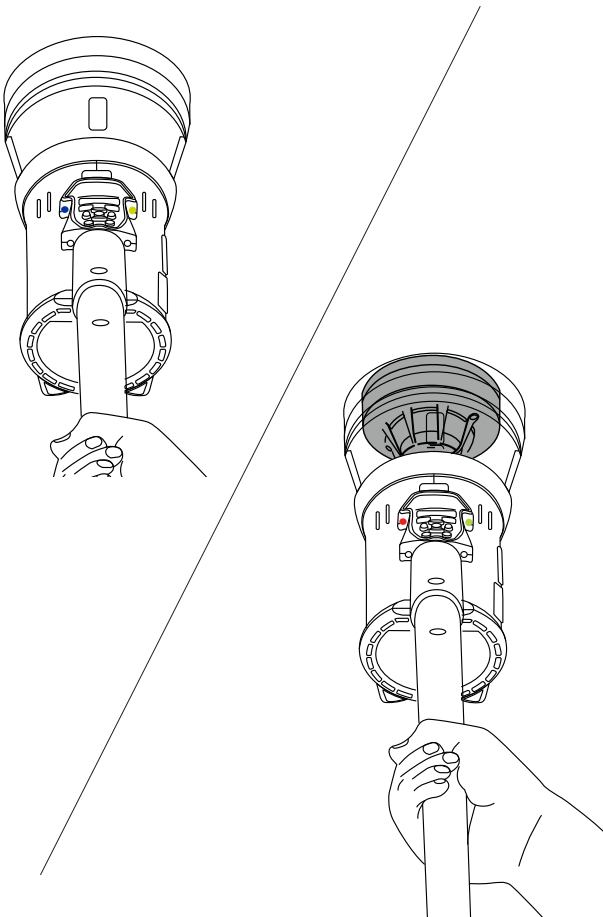
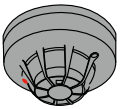

5

Lower Testifire once the heat test has completed. Testifire will return to idle.

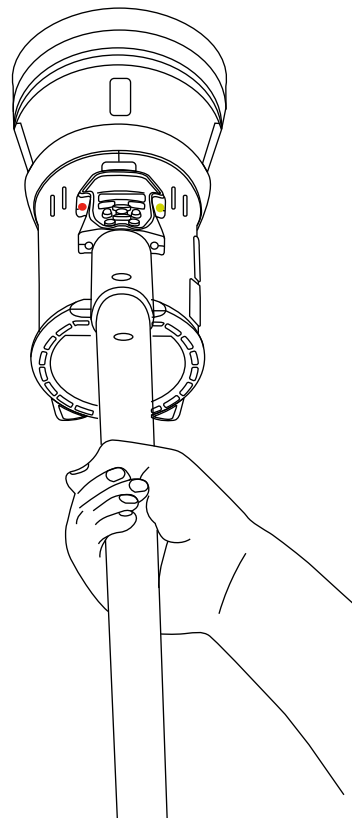
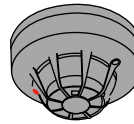

NOTE

If the detector does not re-enter the cup within 10 seconds, the test sequence will reset and return to the first test of the programmed sequence.

6.3 SMOKE TEST + CLEAR + HEAT TEST

1

Select smoke test from the main menu by moving the cursor to smoke. Press the enter key to select smoke.

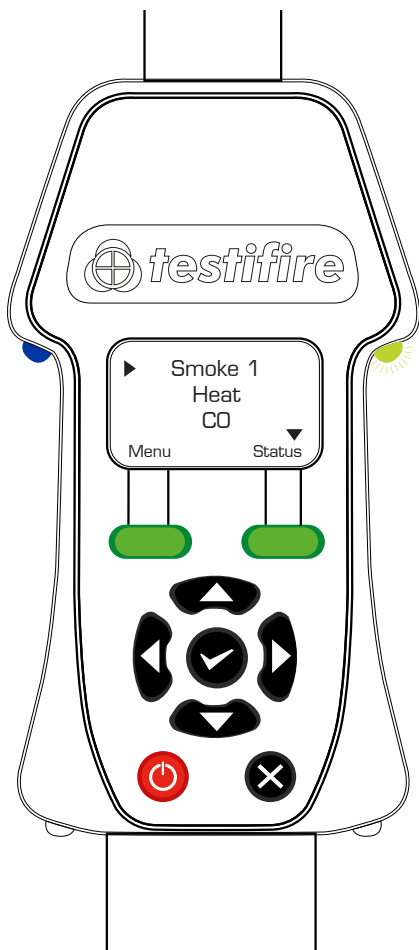

2

Move the cursor down to clear and press the enter key to select.

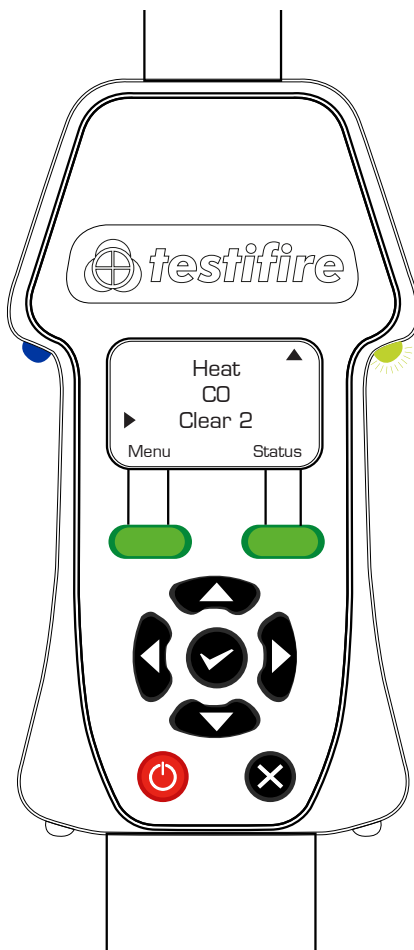

3

Move the cursor to heat and select. All three tests are now programmed and ready to begin.

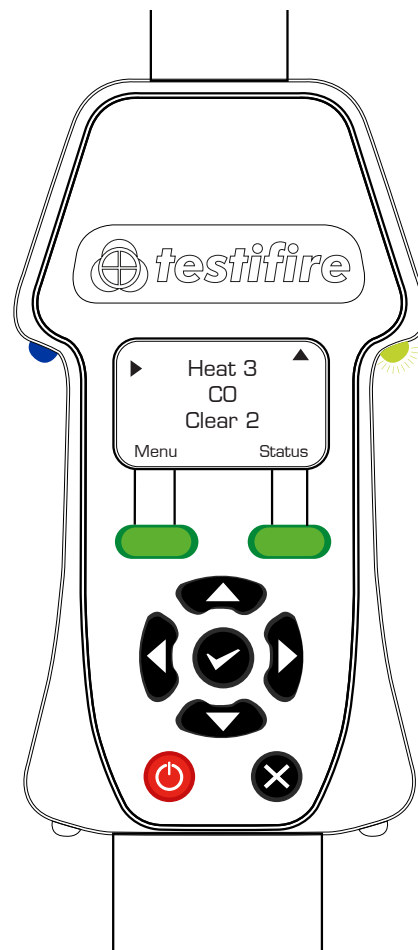

4

The initial smoke test will begin automatically when the head unit is placed over the detector. Breaking the infrared beam.

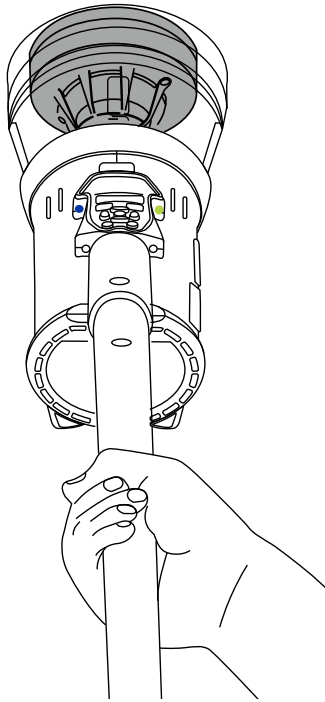

5

When the detector is activated, remove Testifire by lowering it gently. After 2 seconds raise again to begin clearing

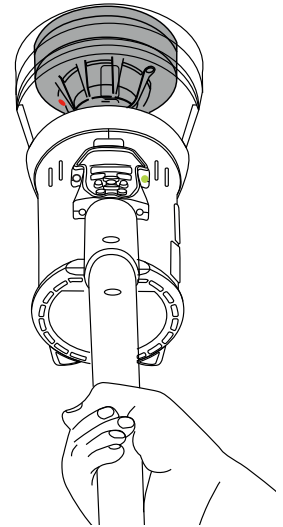
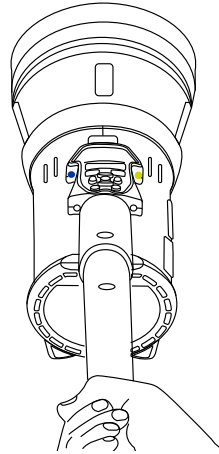
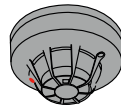

6

Raise Testifire after desired clearing time to begin the heat test.

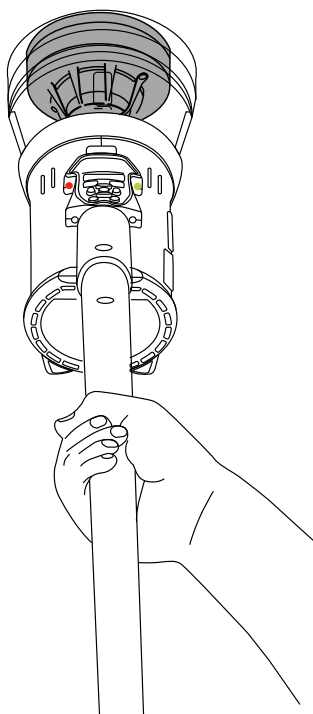

7

When the detector is activated, remove Testifire by lowering it gently. Testifire will return to idle ready for the next detector.

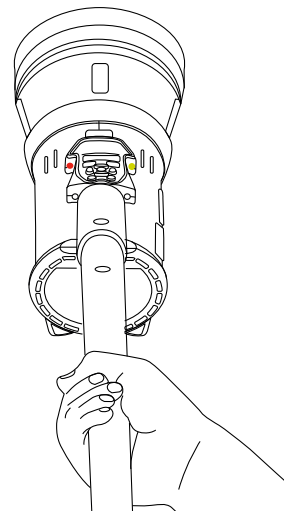
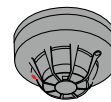

6.4 SMOKE TEST + CLEAR + HEAT TEST + CO TEST

1

Select smoke test from the main menu by moving the cursor to smoke. Press the enter key to select smoke.



2

Move the cursor down to clear and press the enter key to select.

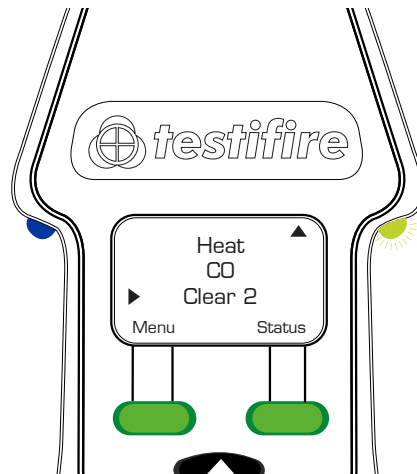

3

Move the cursor to heat and select.

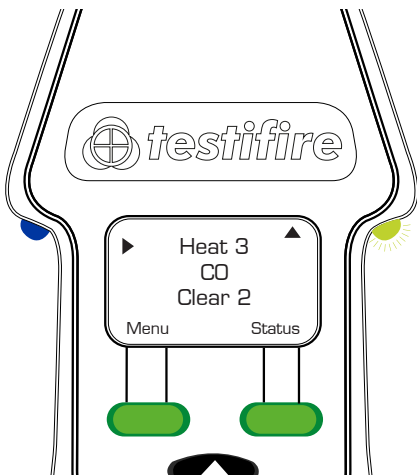

4

Move the cursor to CO and select. All four tests are now programmed and ready to begin.

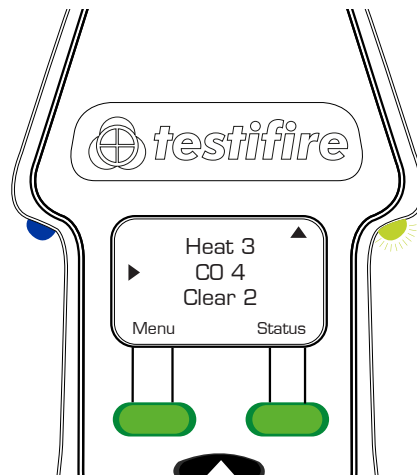

5

The initial smoke test will begin automatically when the head unit is placed over the detector. Breaking the infrared beam.

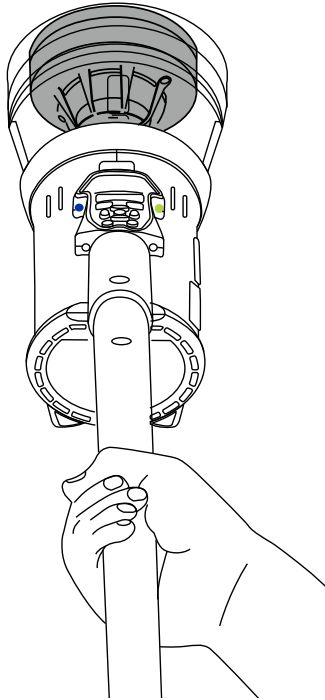

6

When the detector is activated, remove Testfire by lowering it gently. After 2 seconds raise again to begin clearing

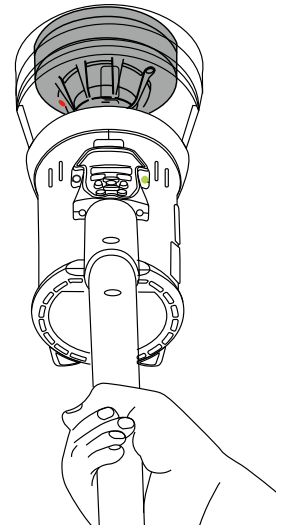
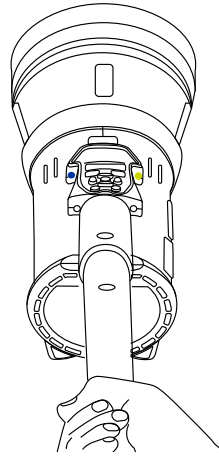
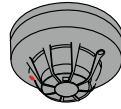

7

Raise Testfire after desired clearing time to begin the heat test.

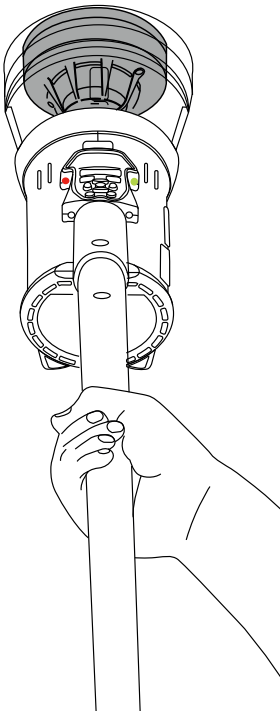

8

When the detector is activated, remove Testfire by lowering it gently. After 2 seconds raise again to begin the CO test.

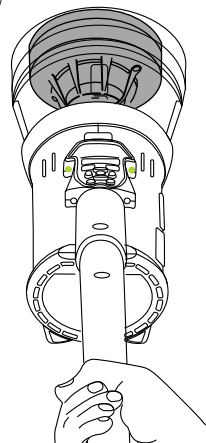
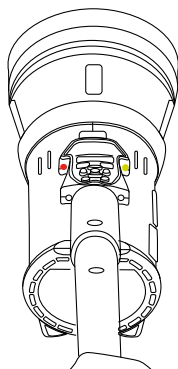
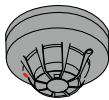

9

When the detector is activated, remove Testfire by lowering it gently. Testfire will cool the CO heater element. The status LED will double flash Green with longer gaps between the flashes. Once the CO heater element temperature has been reduced Testfire will return to idle, ready for the next test.

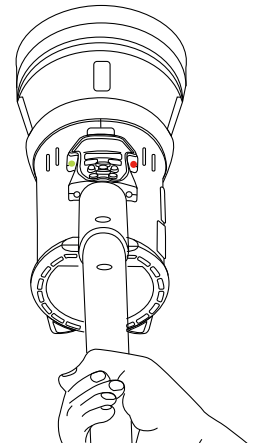
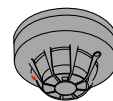

7 SIMULTANEOUS TESTING/ MULTI-SENSOR TESTING

Using Testifire to carry out a Simultaneous Test means that a number of operations (Smoke, Heat and CO) can be pre-programmed into the unit before it is raised up to the detector. This saves time, reduces handling and enables the testing of certain multi-sensor detectors if they are so enabled.

7.1 SMOKE/HEAT/CO

1

Select smoke test from the main menu by moving the cursor to smoke. Press the enter key **Twice** to select. (Indicated by the number **1** beside it)

Move the cursor to heat and press the enter key **Twice** and repeat for CO. all test should have a number **1** beside it.



NOTE

The test LED will alternate the colour of all selected test modes when selected for a simultaneous test.

NOTE

To delete a simultaneous test setup, simply press the escape key to cancel your selection.

2

Raise Testifire over the detector. Smoke, heat and CO are tested at the same time in a simultaneous test.

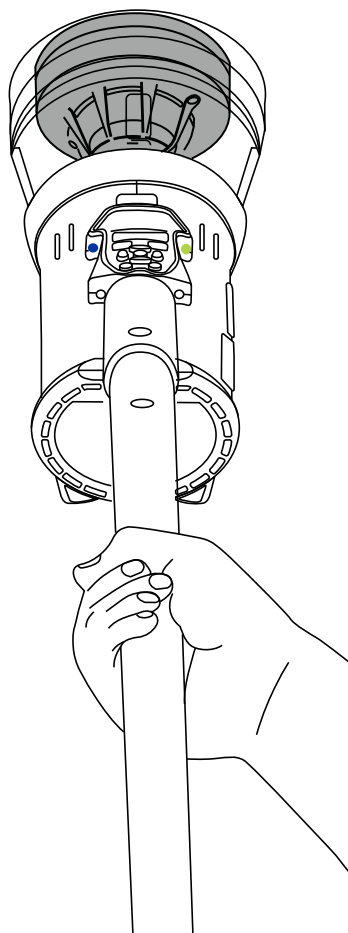

NOTE

Depending on the detection system being tested, there may be no individual indication of the activation of the separate sensors in the detector. The system may activate on one sensor only.

3

Once the alarm is triggered lower Testifire. Testifire will return to idle with the same settings - ready for the next simultaneous test.

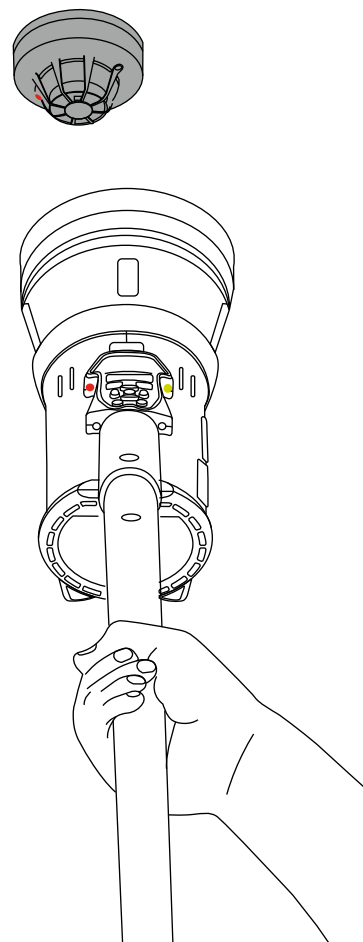

8 TESTIFIRE INFRARED REMOTE CONTROL (AVAILABLE SEPARATELY)

8.1 TESTIFIRE 25

Some types of detector may not automatically initiate a test as they enter the clear cup of Testifire. The Infrared Remote Control can be used to manually start a test, and/or move on to the next test in the sequence. Aim the infrared beam LED at the Testifire head unit when it is at height and use the operation button on the Infrared Control Unit to start/stop a test.

The Infrared Control Unit is powered by two AAA batteries which can be replaced by opening the panel located on the back of the unit.

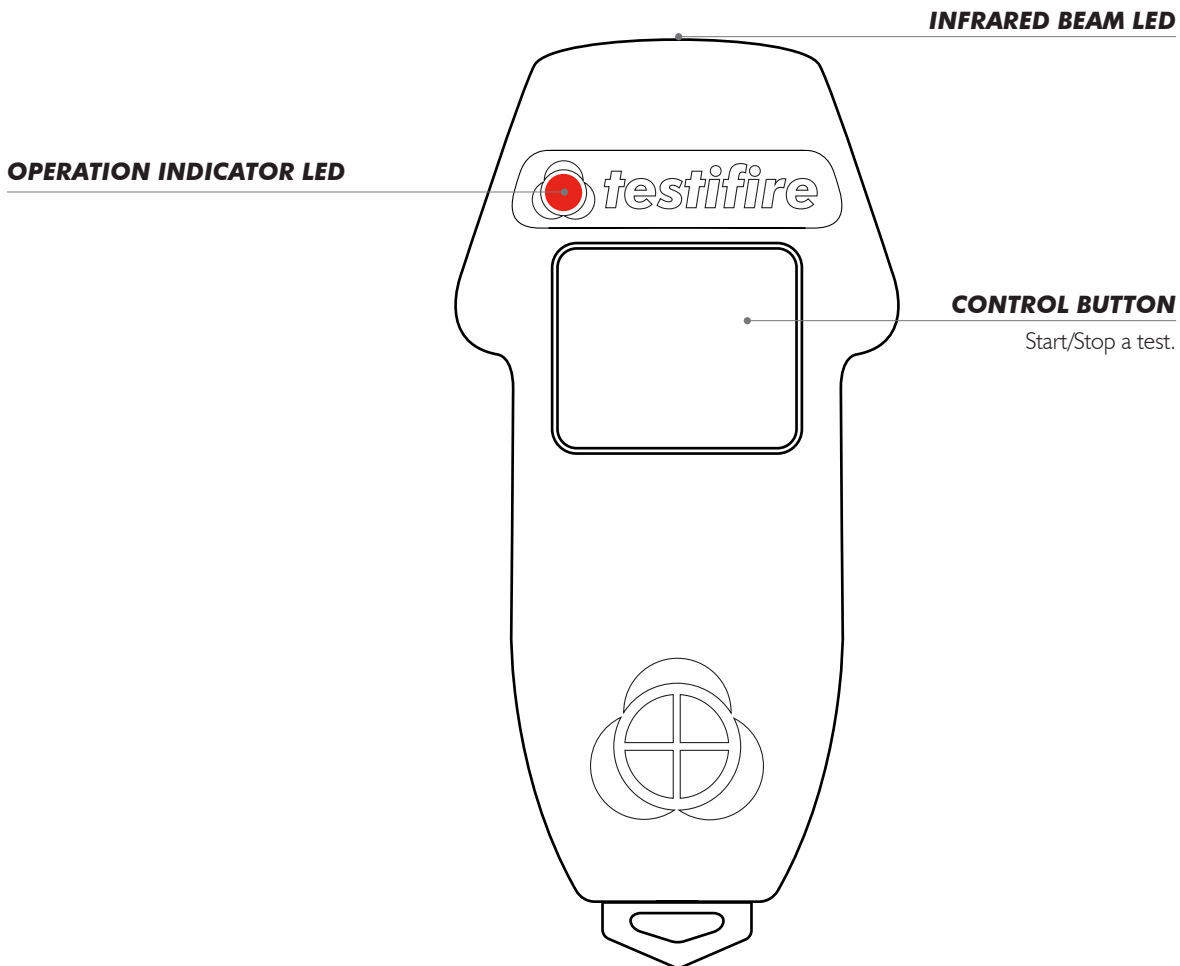

9 SETTINGS

Press the menu key to enter the sub menu.

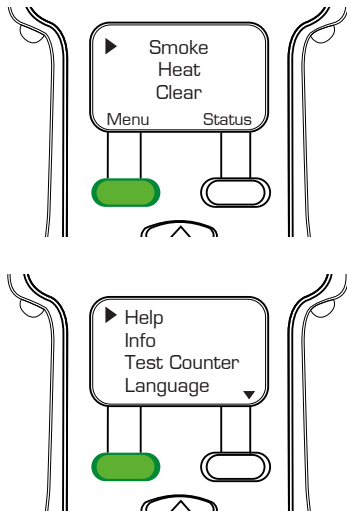

▶ HELP

Find further information on the website or contact Testifire support by emailing support@detectortesters.com

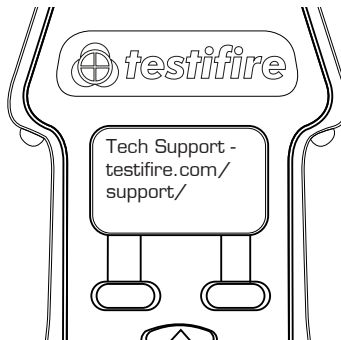

▶ INFO

System information will display the Model, Serial Number, Software Version and the Hardware Version. Warranty information can also be viewed.

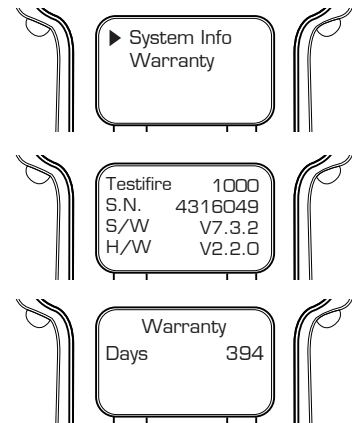

▶ TEST COUNTER

Display the number of tests performed by each test method. You can reset the counters by pressing the menu key.

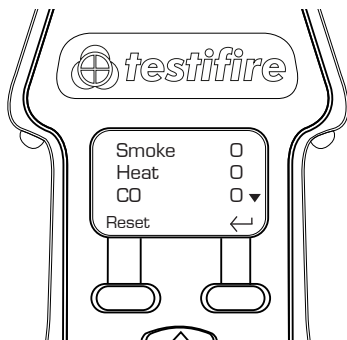

▶ LANGUAGE

Change or Select the system language. You will be prompted to select the system language when powered on for the first time or after a System Rest is carried out.

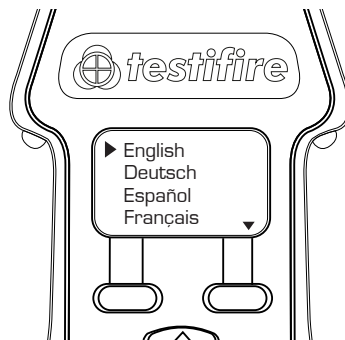

▶ SOUNDER

Enable or disable the keypad and warning sounders. The sounders will be reset if a System Reset is carried out.

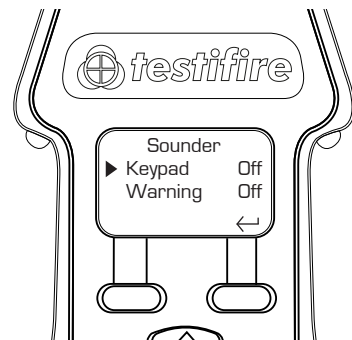

► SERVICE

By default Testfire will notify the user when a Service is due or over due. (Currently 24 months after first switch-on.) If required the Service reminders can be turned off. If a message on the screen shows 'Service Required', but the unit is working, then disable the reminder and continue using your Testfire.



► SYSTEM RESET

Restore Testfire to factory default settings. A System Reset will remove all user customisable settings, including programmed test sequences, the timer and selected language.

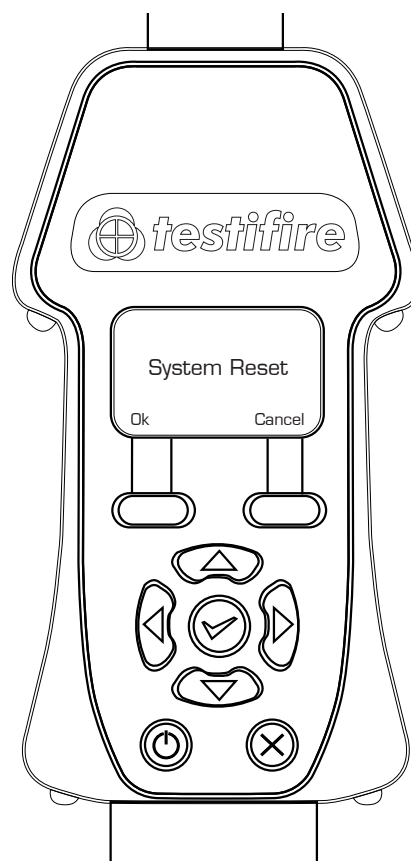

10 REMOVING & REPLACING CONSUMABLES

NOTE

Consumables can be replaced in the field without having to return the unit for service. Ensure that the unit is switched off during the replacement of consumables.



CAUTION

DO NOT TOUCH THE CONTACTS ON THE PCB ON THE CAPSULE.

10.1 REMOVING THE SMOKE CAPSULE

1

Open the smoke access cover on the body of the Testfire.

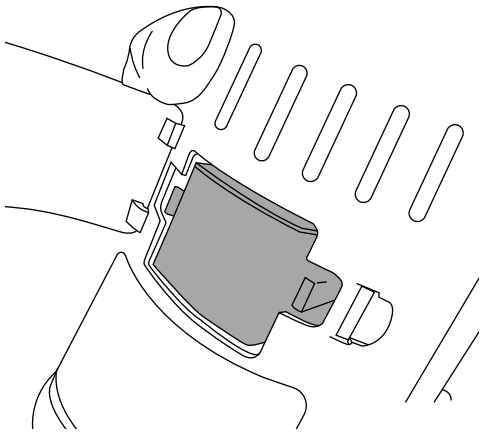

2

Squeeze the two clips on each side of the used capsule and gently pull the capsule out.

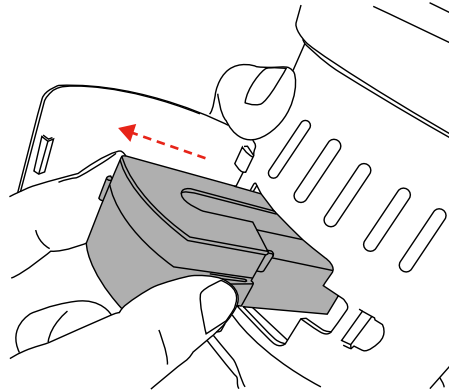

10.2 REPLACING THE SMOKE CAPSULE

1

Remove the spring clip protector cap from the capsule.

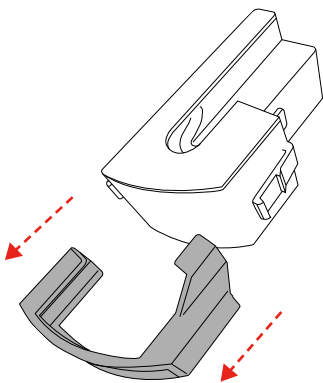

2

Holding the capsule by the spring clips with the label on the underside, insert the capsule. Ensure that the clips spring out positively on both sides of the capsule to engage correctly with the port.

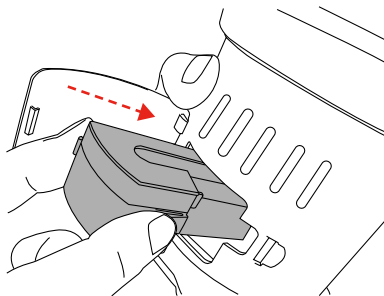

3

Close the access cover securely.

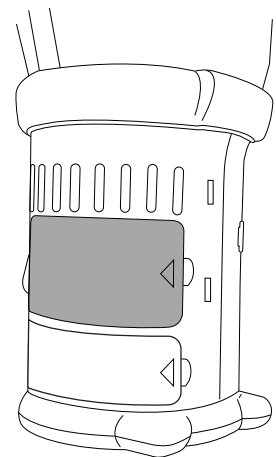



CAUTION

DO NOT TOUCH THE TIP OF THE CO CAPSULE AS IT MAY BE HOT

10.3 REMOVING THE CO CAPSULE

1

Open the CO access cover on the body of the Testifire.

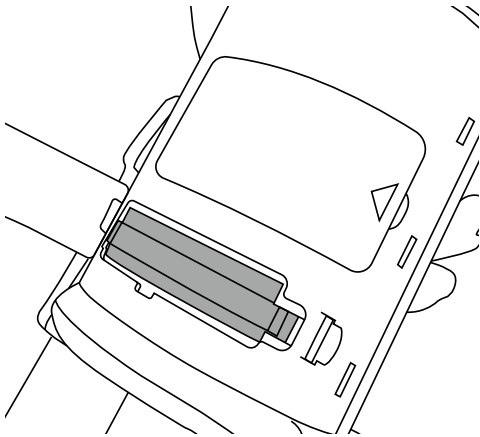

2

Squeeze the two clips on each side of the used capsule and gently pull the capsule out.

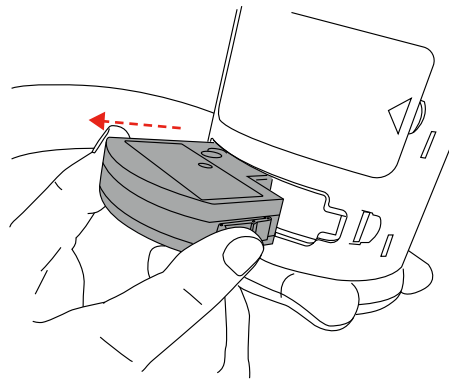

10.4 REPLACING THE CO CAPSULE

1

Remove the tip protector cap from the capsule.

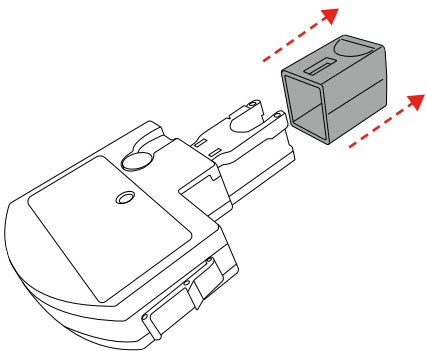

2

Holding the capsule by the spring clips with the label facing upwards, insert the capsule. Ensure that the clips spring out positively on both sides of the capsule to engage correctly with the port.

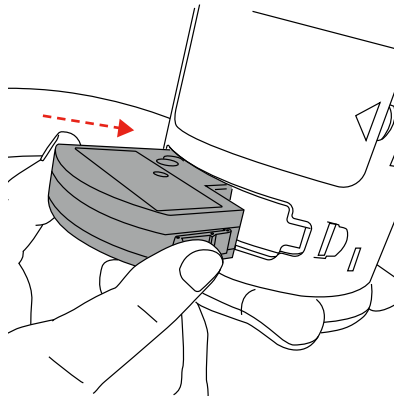

3

Close the access cover securely.

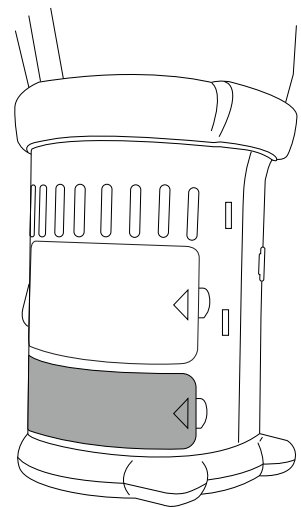

10.5 REMOVING THE BATTERY

Hold the Testfire head unit by the handle. Press the upper spring button on the Battery Baton to release the battery and slide the out of the handle.

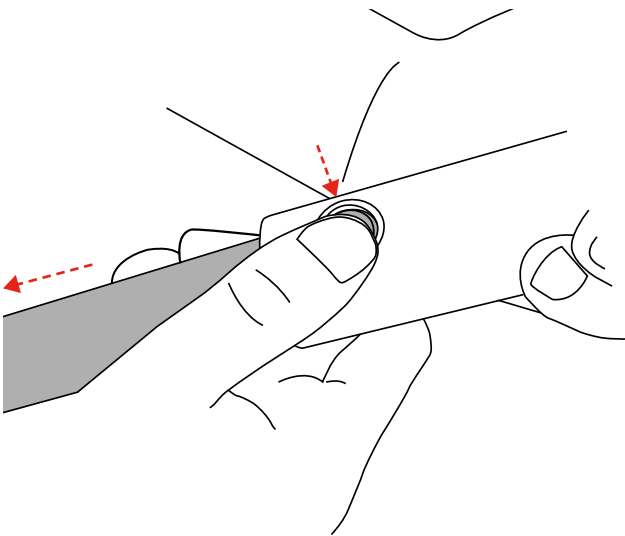

10.6 REPLACING THE BATTERY



CAUTION

ENSURE CORRECT ORIENTATION WHEN INSERTING THE BATTERY BATON INTO TESTIFIRE. DO NOT USE UNDUE FORCE TO INSERT. REMOVE BATTERY FROM TESTIFIRE WHEN NOT IN USE.

Hold the Testfire head unit by the handle and press the upper spring button on the Battery Baton. Align the button with the location hole in the handle and push the Battery Baton into the handle until the button springs up through the hole.

Insert the other end of the Battery Baton into the Solo access pole and press the lower spring button. Align it with the location hole and push the Battery Baton further into the pole until the button springs up through the hole.

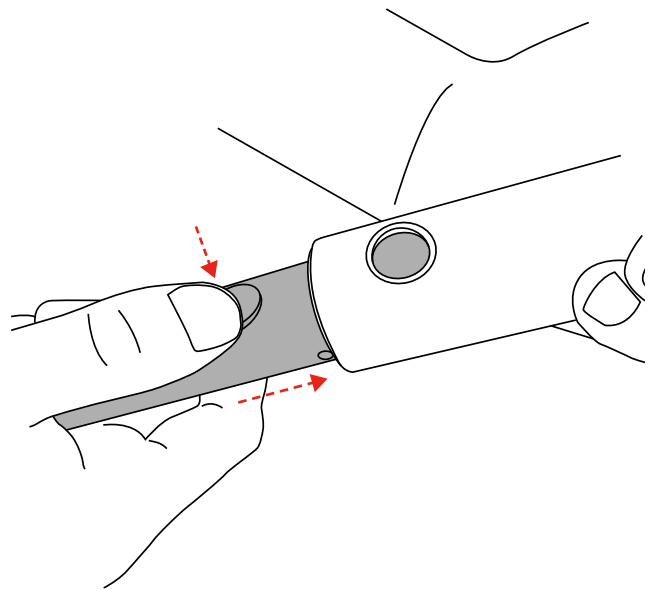

NOTE

Always make sure buttons lock securely. Do not use if there is any damage to the Testfire battery or poles.

11 REMOVING & REPLACING SPARES

11.1 REMOVING THE CLEAR CUP

Hold the clear cup using the cut-out, and pull up firmly.

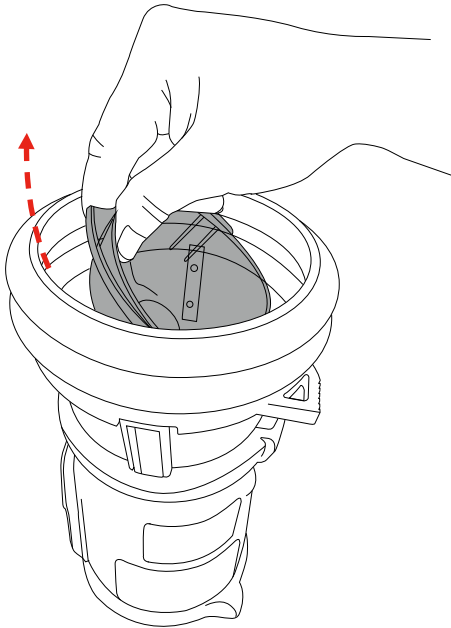

11.2 REPLACING THE CLEAR CUP

Line the cup with the rectangular cut-out in line with the smoke/heat duct. Press the cup down from the middle until it clicks into place.

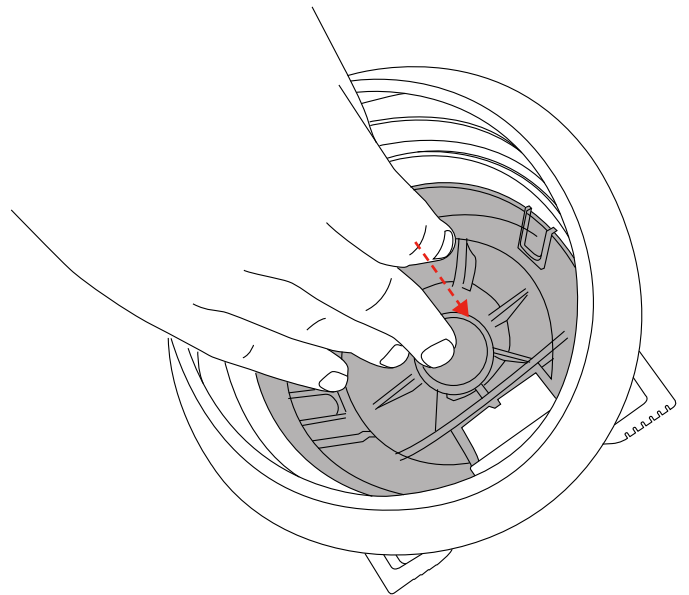

11.3 REMOVING THE MEMBRANE

Pull the membrane upwards to remove.

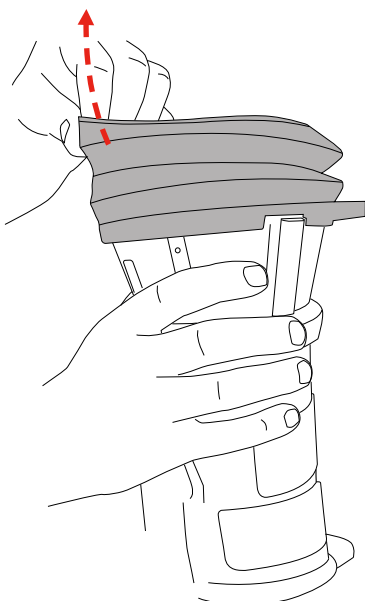

11.4 REPLACING THE MEMBRANE

Line up the membrane with the two flat supports nearest the smoke/heat duct. Work the membrane round the plastic cup, making sure the cup fits into the slot in the membrane.

Finally, pull the membrane over the last edge of the cup.

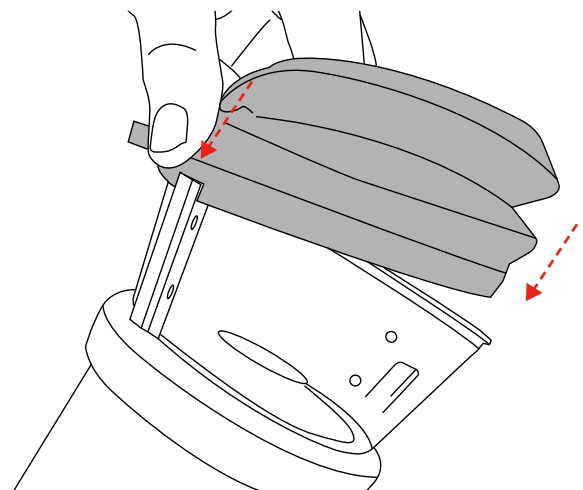

12 CONSUMABLES & ACCESSORIES

Use only approved accessories that are recommended by the manufacturer for your Testifire model.

Testifire does not contain any field serviceable parts. The following spare and consumable parts are available to order from your distributor.

Ordering Information	
TS3 Smoke Capsule 3 pack	TS3-3PACK-001
TS3 Smoke Capsule 6 pack	TS3-6PACK-001
TC3 CO Capsule 3 pack	TC3-3PACK-001
TC3 CO Capsule 6 pack	TC3-6PACK-001
Membrane	SPARE-1049-001
Inner Cup	SPARE-1048-001
Battery Baton	Solo 770-001
Charger	Solo 727-001
Testifire 25 Infrared Remote Control	Testifire 25-001

Additional Items	
Solo 100 Telescopic Access Pole	Solo 100-001
Solo 101 Extension Pole	Solo 101-001
Solo 110 Urban Telescopic Pole	Solo 110-001
Solo 111 Urban Extension Pole	Solo 111-001
Solo 200 Universal Detector Removal Tool	Solo 200-001
Solo 611 Urban Backpack	Solo 611-001
Solo 610 Protective Bag	Solo 610-001

Kits	
Testifire 1001 Test Kit	Testifire 1001-001
Testifire 1001-I Test Kit	Testifire 1001-I-001
Testifire 6001 Test Kit	Testifire 6001-001
Testifire 6001-I Test Kit	Testifire 6001-I-001
Testifire 9001 Test Kit	Testifire 9001-001
Testifire 9001-I Test Kit	Testifire 9001-I-001
Urban Smoke / Heat Test Kit	URBAN1001-I-001
Testifire 2001 Test Kit	Testifire 2001-001
Testifire 2001-I Test Kit	Testifire 2001-I-001
Testifire 6201 Test Kit	Testifire 6201-001
Testifire 6201-I Test Kit	Testifire 6201-I-001
Testifire 9201 Test Kit	Testifire 9201-001
Testifire 9201-I Test Kit	Testifire 9201-I-001
Urban Smoke / Heat / CO Test Kit	URBAN2001-I-001

13 TECHNICAL SPECIFICATIONS

Power Source	Battery Baton: nominal 7.2V 3.0Ah NiMH rechargeable battery pack with internal overcurrent protection connects directly to Testfire with no leads or wires. Must be charged by Solo 727 Battery Charger (using 100-230VAC or 12VDC input).
Battery Charge Time	Approx. 90 mins. (if completely discharged).
Power Consumption	Dependent on mode of use: Smoke testing: <0.5A rms Heat testing: 4-6A rms CO testing: 2-5A rms N.B. Power consumption refers only to the duration of the actual test and may vary considerably due to internal control algorithms.
Test Modes	Smoke: a simulated smoke generated internally using a miniature heat exchanger and a harmless liquid from the smoke capsule. Normal Heat: to test rate-of-rise and fixed temperature heat detectors up to 90°C (194°F). Hi Heat: to test rate-of-rise and fixed temperature heat detectors up to 100°C (212°F). Carbon Monoxide (CO): CO is generated internally and blown into the detector at a concentration of approximately 100ppm (not calibrated). CARBON MONOXIDE (CO) IS A HARMFUL, ODOURLESS GAS AND CARE SHOULD BE TAKEN NOT TO INHALE DIRECTLY FROM THE DUCT DURING A CO TEST. Clearing: clean air is blown to remove previously applied smoke. Simultaneous Testing: Smoke or Heat in any combination as programmed by the user are all carried out in one test. Sequential Testing: Tests are performed according to the order that they have been programmed by the user.
Safety Features	Battery over-current cut-out. Default 2 minutes maximum test duration timeout. Auto power off after 10 minutes of non-use. CO generated on demand (no gas stored).
Operating Features	Colour coded LED user feedback. Automatic infrared sensing of the detector. Adjustable multi-position head.
Suitable Detector Types	Optical / photoelectric and ionisation smoke detectors. Thermal sensors (fixed temperature or rate-of-rise). Carbon Monoxide (CO) fire sensors. Multi-sensors or multi-criteria detectors. Conventional, addressable or analogue addressable detectors of any of the above types.
Environment	Operating temperature range: +5°C to +45°C (41°F to 113°F). Operating humidity range: 0 to 85% RH non-condensing. Storage temperature range: -10°C to +50°C (14°F to 122°F). Storage humidity range: 0 to 90% RH non-condensing (up to +35°C / 95°F).
IP Rating	Rated according to IEC60529 to IP20
Weights	Testfire 1000: 1.14g (excluding Battery Baton) Testfire 2000: 1.23kg (excluding Battery Baton) Solo 770 Battery Baton: 0.5kg
Dimensions	Testfire 1000: Bellows width: 153mm max. Head Unit height: 224mm max. (397mm including handle) Testfire 2000: Bellows width: 153mm max. Head Unit height: 273mm max. (397mm including handle)

NOTE:

Product specifications may be subject to change without prior notice or obligation on the part of the manufacturer.

International Patents

Testfire is protected by the following patents:

EP(GB)0910055B1, DE69820382.8, US6423962, EP(FR,GB)1290661B1, DE60112442.1, ZL01801074.1, US6640608, EP(FR,G-B)1390927B1, DE50205116.7, DE60314594.9, GB2385179, EP(DE)1468409B1, GB2409319B, US8049612, EP(GB)1794728B1, DE602005037919.3, EP(FR,GB,NL,SE)1960980B1, IT502013902154897, DE602006034660.3, US8966952, JP4958914

14 TROUBLESHOOTING & SUPPORT

If you experience any type of problem with your Testfire, turn the power off, wait for a few seconds and then turn the power back on. This may clear the fault. If the fault continues, the following information may help you solve the problem. If you are unable to identify the cause of the problem, please visit detectortesters.com/support

14.1 IDENTIFYING ERRORS

- When an error occurs, the Status LED will appear red and the Test LED will not be illuminated. This can be clearly seen without access to the screen when the unit is at height.
- The unit will emit a 2 second warning sound (if the sound is enabled) and cease to function further. The screen will display the error message.
- In some cases the error message may be cleared from the screen by pressing the escape key. This may enable the unit to continue operating, although if the error has not been corrected the error message may reappear immediately on screen.
- You will need to correct the error in order to proceed. For example, if the battery is Low, the screen will display the message 'Replace Battery'. In this case, no further testing can be carried out until the Battery Baton has been recharged or replaced.

14.2 GENERAL CARE

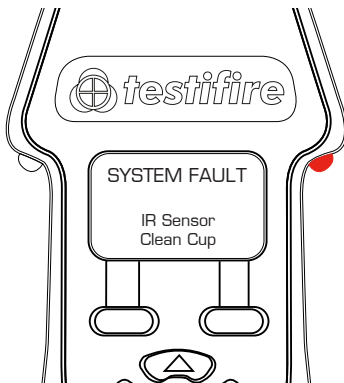

Dirt that gets into the cup could get into the unit through the smoke/heat/co duct Opening and cause the unit to fail. Always keep the cup clean to ensure reliable operation.

1. Debris (e.g. from ceiling tiles) can fall into the test cup, and could work their way into the unit, causing the fan to stop.
2. Remove inner test cup.
3. Attach a charged battery baton.
4. Turn on Testfire and set to clear only program. (Press the up / down buttons until the cursor is next to 'Clear').
5. Adjust handle to 90° position away from the Testfire body
6. Holding the baton and handling tube vertically, use a brush to brush the dirt out of the test cup, moving dirt away from the duct.

7. While your hand is inside the test cup, and Testfire programmed to Clear, air will be blow out of the duct and aid clearing. It will also help prevent loose debris from entering the duct.
8. Take care not to damage the heater elements in the duct.
9. Use a damp lint-free cloth to wipe inside of the test cup to remove any remaining small particles of dirt.
10. Clean inner cup using lint-free cloth, and re-fit into the unit.
11. Clean bellows, and re-fit
12. Wipe the rest of the unit.

DO NOT DROP OR EXPOSE TESTIFIRE TO WATER.

Always store Testfire, batteries and chargers in a suitable bag when not in use.

14.3 BATTERIES & CHARGERS

Solo NiMH Battery Batons are used to power Testfire and enable it to be fitted to Solo Access Poles.



WARNING

DO NOT ATTEMPT TO USE OR CHARGE THE BATTERY IF EITHER THE UNIT OR THE BATTERY CONNECTION POINT ARE DAMAGED. NEVER CONNECT AC AND DC POWER AT THE SAME TIME.

The Solo 770 Battery Baton must be charged before using Testfire. To ensure maximum duration of testing, it should be fully charged for each use. Solo 727 chargers will only work with Solo 770 battery batons. They will not charge Solo 760 Batteries.

SOLO 727 CHARGER

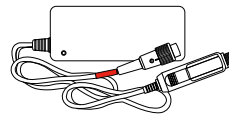

SOLO 770 BATTERY

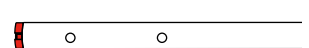

SOLO 726 CHARGER

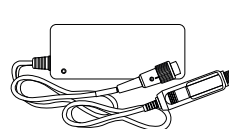

SOLO 760 BATTERY

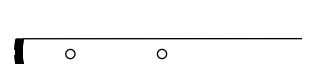



As our policy is one of continuous improvement, details of products described within this publication are subject to change without notice. All information provided here is believed to be correct at the time of going to press. Every effort has been made to ensure the accuracy of information which is provided in good faith but nothing contained herein is intended to incorporate any representation or warranty, either express or implied or to form the basis of any legal relations between the parties hereto, additional to or in lieu of such as may be applicable to a contract of sale or purchase.